

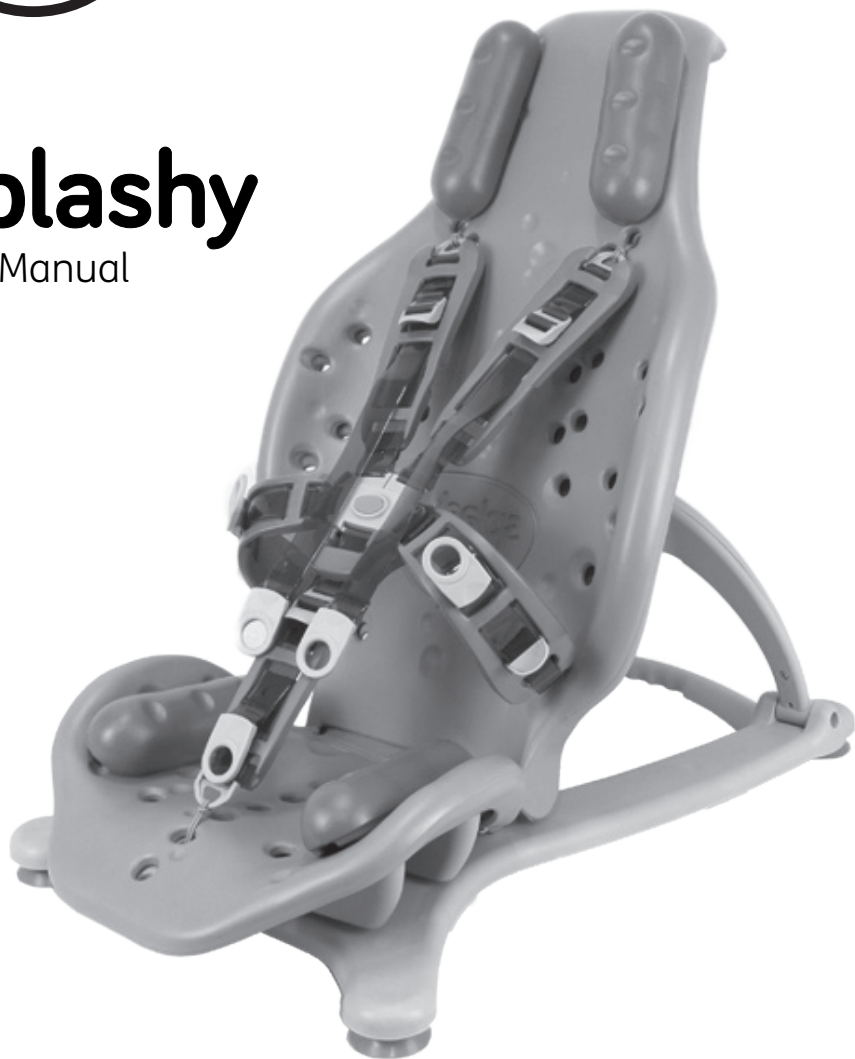

# Splashy

User Manual



Family Freedom



Please read all user instructions carefully before using Splashy. These instructions can also be downloaded from our website **[www.fireflyfriends.com](http://www.fireflyfriends.com)** along with videos, diagrams and other useful downloads.

---

## Contents

01 Intended Use	p.03
02 Declaration of Conformity	p.04
03 Warnings and Cautions	p.04
04 Terms of Warranty	p.06
05 Safety Information	p.07
06 Precautions and Contraindications	p.08
07 Cleaning and Care Information	p.09
08 Product Inspection and Servicing	p.11
09 Important Guidelines	p.12
10 Re-issuing Firefly Products	p.12
11 Instructions for Use	p.13
12 Sizing Information	p.33
13 Table of Symbols	p.34

---

## SECTION 01: Intended Use

### Intended Use

Bathing Supports are intended to support children and young adults who have mild to complex postural needs that disrupt the ability to sit without external support. All devices are intended to be used within a bath or shower to facilitate personal care. Splashy can additionally be used outdoors for recreational purposes such as use at a beach or water park.

### Indications for Use

Splashy is intended to provide support for children with disabilities who require head and trunk support whilst using the bath. For structure, safety and support, it is essential that Splashy is attached to the floorsitter base unit at all times. Splashy is designed for children aged between approximately 1–8 years old and with a maximum user weight of 30kg (66lbs).



Children should not be left unattended/unsupervised in their Splashy at any time, as they could be at risk of drowning or injuring themselves.

We recommend that an adult completes product inspections in accordance with Section 08 of this user manual to ensure the product is safe to use. Firefly Friends Ltd. and James Leckey Design Ltd. cannot accept any responsibility if the product is used outside of its intended use. If in doubt please contact Firefly customer services on UK 0800 318265 or ROI 1800 626020.

Daily activities tested and approved by Firefly Friends Ltd and James Leckey Design Ltd are:

1. In the bath or shower
2. For water play activities

---

**Use of Splashy outside the bathroom, (such as the garden or beach) should be assessed in advance. Be mindful that Splashy contains working floorsitter-to-seat connections which could be affected by small particles and/ or obstructions (such as soil, grass or sand). If Splashy does come into contact with any substances that could affect the floorsitter-to-seat connections, ensure they are thoroughly rinsed after use. Please refer to Section 05 for Safety Information and Section 07 for further guidance on cleaning and care.**

## SECTION 02: Declaration of Conformity

The Splashy is classified as a Class I Medical Device under EU and UK regulations. James Leckey Design Ltd as manufacturer with sole responsibility declares that the Firefly Splashy conforms to the requirements of the 93/42/EEC Guidelines, Medical Device Regulations 2017, UK Medical Devices Regulation 2002 and EN 12182 Technical aids for disabled persons and test methods.

**Notice to the user and/or patient: Any serious incident that has occurred in relation to the device should be reported to the manufacturer and the competent authority of the Member State in which the user and/or patient is established.**

**NOTE:**

**General user advice.**

**Not following these instructions may result in physical injury, damage to the product or damage to the environment!**

---

## SECTION 03: Warnings and Cautions

**Warning and Toppling Hazard:**

- Never use Splashy on uneven ground.
- Always check that the seat back is secure before the user is transferred into Splashy and the user's foot safety straps are being used as soon as the user is seated.
- Never leave the child unattended whilst seated in Splashy.

**Caution Daily Checks:**

- Splashy is to be checked daily before use to ensure that all harnesses and seating elements are securely attached.
- Always visually inspect the product before use. If in doubt, STOP. If you suspect or know the product or a part is faulty, STOP. Contact our customer services department or your local dealer as soon as possible.

**Caution Finger Pinch Hazard:**

- Take care when assembling or adjusting the position of the seat components that your fingers do not get pinched when positioning seat components and tightening mountings.
- The carer should not touch any moving joint or pivot that is not locked.

**Warning Finger Trap Hazard:**

- Take care that the fingers of the operator or child do not get trapped in the spaces between the seat and the frame.

**Warning Occupant Security:**

- Before placing the user in the product, adjust the product into its therapy orientation and check its stability.
- User transfers in and out of the product must be done with appropriate equipment and personnel.
- Ensure that the occupant is secured with the device harnesses as soon as they are transferred. Care should be taken with any recline adjustments for involuntary movements which might cause entrapment between the seat and frame/bath. Never

leave the child unattended whilst in Splashy.

- User toppling risk - if the belts need loosened during hygiene activities the child could slip down or, due to lack of trunk control, they could topple face forward.
- Drowning risk for reclining product in a very deep bath.
- If the user exhibits any form of distress, remove from the product as quickly as is safely possible.

**Caution Cleaning:**

- Clean the product regularly to prevent the build-up of dirt. Accumulated dirt can prematurely wear the seat mouldings and encourage corrosion in the frame. Only use non-abrasive household cleaners and moist cloths.

**Caution Cleaning Power Washer/ Hoses:**

- Do not use hoses or power washers on the frame components, the frame is not sealed against running water and may be damaged by water ingress.

### **Caution Storage:**

- The product should be kept away from all direct sources of heat, including naked flames, cigarettes, electric and gas heaters.

### **Caution Bringing into Use:**

- When bringing Splashy into use from storage, allow it to acclimatise to ambient temperature first.

### **Caution Disposal:**

- Only dispose of Splashy in a community waste disposal site under the correct recycling category.

---

## **SECTION 04: Terms of Warranty**

The warranty for Splashy applies only when the product is used according to its intended use, following all manufacturer's specifications. A one year warranty is provided with this James Leckey Design Ltd. manufactured product.

Goods can be returned to us for warranty, repair or replacement up to 12 months from receipt. Once you contact us, we will arrange collection of the goods at our expense and, once returned to us we will repair or replace goods and return them to you within 14 days. In all cases, it is the customers' responsibility to ensure the goods being returned are suitably packaged, preferably in the original packaging.

## SECTION 05: Safety Information

1. Always read user instructions fully before use.
2. Children should not be left unattended/unsupervised at any time in this product.
3. If using Splashy at the beach, never leave your child unattended near the sea.
4. Check that all of the Splashy components are securely assembled according to user instructions before use. Splashy must be attached to the floorsitter base unit at all times and placed on a firm, solid, static surface. Never use Splashy on a sloping surface.
5. The maximum user weight for Splashy is 30kg (66lbs). **This should never be exceeded.**
6. Splashy contains parts which could present a choking hazard to small children. Check all components are tight and securely fastened before use – including toggles and straps.
7. **Do not** modify Splashy or use components other than Firefly approved components with Splashy at any time. This may put your child at risk and may also invalidate your warranty.
8. When using Splashy in environments which may have soil/sand/grass or small components, always ensure that you clean out the floorsitter-to-seat connections after every use to prevent any obstructions. For reconnecting floorsitter to seat please refer to Section 11.2.6
9. After use, allow Splashy to dry thoroughly before storing it away carefully. Splashy should be kept away from all direct sources of heat including naked flames, cigarettes, electric and gas heaters.
10. Clean the product regularly in accordance with Section 07 of this user manual.
11. Complete maintenance checks on a **regular** basis to ensure your product is in good working condition. Splashy should not be used if any of the parts are faulty.
12. If you are in **any doubt** about the safe use of Splashy or the floorsitter base unit, or if any parts should fail, please cease using the product immediately and contact Firefly customer services on UK 0800 318265 or ROI 1800 626020.
13. Any promotional items supplied with Splashy should not be used unsupervised.



Failure to follow these instructions may put you or the child at risk.

## SECTION 06: Precautions and Contraindications

### Precautions

- Fixed spinal deformities such as scoliosis or kyphosis.
- Severe muscle contractures.
- Severe muscular or skeletal asymmetry including hip dislocation.
- Progressive and muscle wasting conditions.
- High risk or recent history of bone fractures.
- High risk of pressure related injury or open sores.
- Strong, uncontrolled movement patterns.
- Poorly controlled seizure activity.
- Children dependent on the use of percutaneous endoscopic gastrostomy.
- Medical instability including compromised respiratory or cardiovascular function.
- Dependant on 3rd party life-sustaining apparatus such as oxygen tanks.
- Significant learning disabilities and/or behavioural issues.

### Contraindications

There are no contraindications associated with bathing devices. The instructions for use indicate that for all products, no child or young adult should be left unintended in the device when in use or contact with water.

All precautions and contraindications are taken at the discretion of the parent or prescribing clinician.



## SECTION 07: Cleaning and Care Information

### How to Maintain

- When cleaning Splashy we recommend that you use only warm water and a non-abrasive detergent. Never use organic solvents or dry cleaning fluids.
- Do not machine wash or steam clean Splashy's foam components as it may cause the foam to lose shape and warp.
- We recommend that you do not use any type of prescribed medicated lotions in the bath water during the bathing process as this may contribute to the breakdown of Splashy's materials.
- Wipe the bath surface clean of any residue or dirt before attaching the floorsitter to it, ensuring the rubber feet grip firmly to the bath.
- To remove sand/soil/grass or any small particles that may be in the floorsitter-to-seat connections, slight tapping of the area will encourage the particles to fall out. Rinse thoroughly to ensure there is no build up of particles inside the connections. For stubborn blockages on the floorsitter, the latch can be given a thumb push to remove any particules and aid release.
- Should your bath seat come into contact with salt water, rinse all parts thoroughly with fresh, clean water.

### 5-point Harness

The Splashy 5-point harness can be removed and cleaned with soapy water.

---

### Floorsitter Base Unit

1. Ensure the bottom of the floorsitter base unit is cleaned after every use to ensure it grips onto the bottom of the bath.
  2. Soap and water can be used for daily cleaning.
  3. Do not use solvents to clean the floorsitter base unit.
- 

### Splashy Foam Seat Base, Backrest and Supports

1. Soap and water can be used for daily cleaning.
2. The EVA foam covers can be removed and washed periodically to avoid a build-up of residue and grime.

**Splashy's EVA foam covers can be removed and washed every few months.**

1. The EVA covers are attached by eight hooks. Two on the seat back and six on the seat base.
2. Detach all hooks by hand (do not use tools).
3. Wash using soapy water.
4. Ensure the covers are completely dry before reattaching.
5. Ensure all hooks are engaged when putting the covers back on.

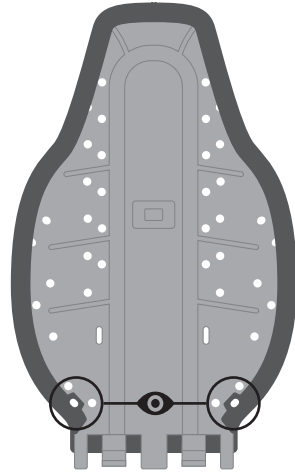

Hook locations

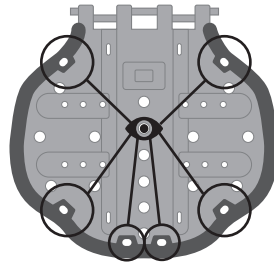

 If Splashy is being used in environments outside of the bathroom, (such as the beach or garden) it is important to rinse it after every use so that it is free from any particles/obstructions that could affect its working mechanisms. For reconnecting floorsitter to seat please refer to Section 11.2.6

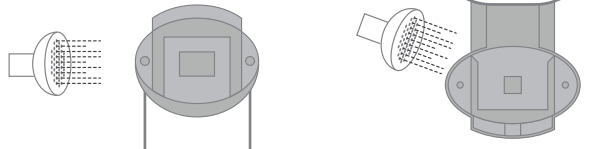
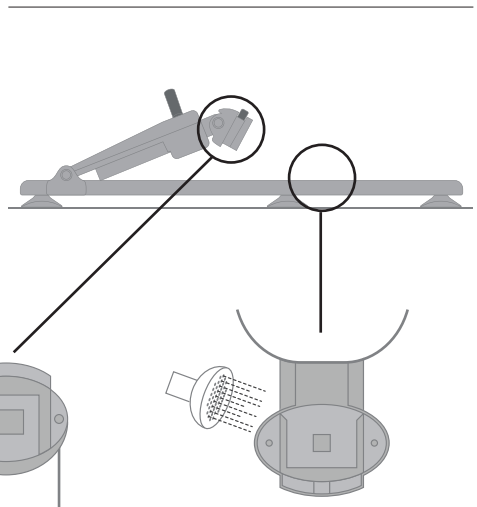

## SECTION 08: Product Inspection and Servicing

**We recommend that various checks of Splashy are carried out before each use to ensure the product is safe.**

The recommended checks are listed below:

1. Ensure that the Splashy back rest and seat base have been **fitted securely together** as detailed in Section 11 of this manual.
2. Check that Splashy is **fixed correctly to the floorsitter base unit** and ensure it is stable and secure in the bath before placing the child in.
3. Ensure the 5-point harness and bumper supports are **securely fixed** to Splashy using the toggle fixtures.
4. Check the 5-point harness and bumper supports for **any signs of wear or tear**.
5. Check the buckles and toggles for cracks or damage.
6. Check Splashy and Floorsitter latches and connections are clear of dirt or debris with **no signs of wear and tear**.



If you are in any doubt about the safe use of your Firefly product or if any parts should fail, please cease using the product and contact our customer services department as soon as possible.

For all service related issues please refer to the Firefly website **[www.fireflyfriends.com](http://www.fireflyfriends.com)** or contact Firefly on **[customer.enquiries@fireflyfriends.com](mailto:customer.enquiries@fireflyfriends.com)**

## SECTION 09: Important Guidelines

Ensure that Splashy is sitting securely in the bath. Recline the back rest into a mid-recline position for children who can assist with transfers or are lifted into the bath. Please refer to section 11.6

Full recline should be used for children who will be hoisted into the bath. This should make transfers into Splashy easier.

We would advise you fit the 5-point harness and bumper supports to Splashy before you place the child into the seat, however, they can be adjusted if necessary once your child is in the bath. Please exercise caution and monitor your child closely whilst alterations are being made to the bath seat.

Lifting a child in and out of the bath is an activity which could cause injury to your back. We would **recommend you seek advice from you therapist** with regards to safe lifting (manual handling techniques) of your child in and out of the bath.

## SECTION 10: Re-issuing Firefly Products

Before re-issuing a product, it is recommended that it is disinfected using one of the following procedures:

**Note: Always clean the product first to remove accumulated soiling prior to disinfecting/sanitising.**

1. Where possible, we recommend the use of an automated “fogger” disinfection system that is used to completely cover the product surfaces with a disinfectant agent. The manufacturer’s instructions for the chosen system should be referred to prior to use and followed exactly.
2. Where an automated disinfection system is not available, all product surfaces should be wiped over with disinfectant surface wipes or liquid disinfectant on a soft cloth. Suitable products are 70% IPA, 70% Alcohol or diluted bleach. The manufacturer’s instructions for the chosen product should be followed. Product upholstery and fabrics should be cleaned thoroughly in accordance with section 07, Cleaning and Care Information, of this manual.

Ensure a copy of the user manual is supplied with the product. If in any doubt about the continued safe use of your Firefly product or if any parts should fail, please cease using the product and contact our customer service department as soon as possible on UK 0800 318265 or ROI 1800 626020.

# SECTION 11: Instructions for Use

## 11.1 Splashy Parts



The Splashy duck is to be used under the direct supervision of an adult

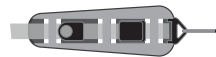
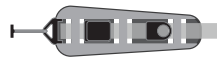
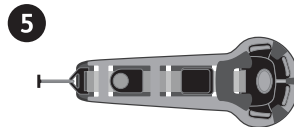
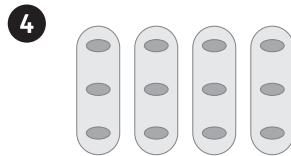
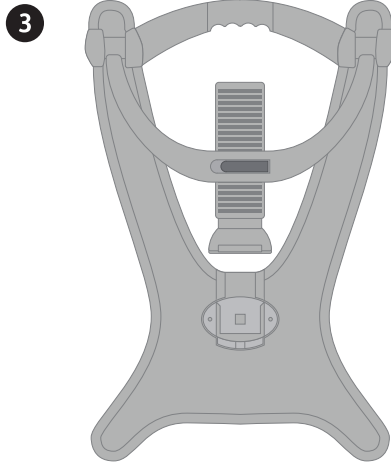
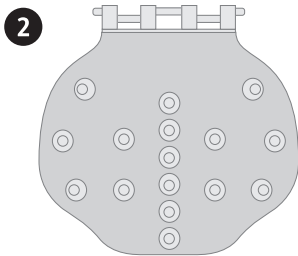
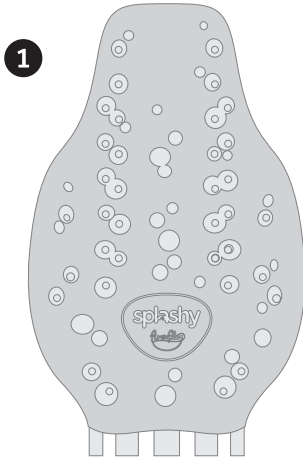

Your Splashy will arrive with the following parts:

- 1** 1x Back rest
- 2** 1x Seat base
- 3** 1x Floorsitter base unit
- 4** 4x Bumper supports
- 5** 1x Groin strap & 4x Harness straps

## 11.2 Assembling Splashy

- We highly recommend that you complete a 'dry run' with your child in Splashy whilst wearing light clothing to ensure correct placement of harness and bumper supports.
- Make sure your bath is clean and free from any residue before placing the floorsitter into the bath.
- Your Splashy **MUST** be assembled **BEFORE** filling the bath with water. We recommend you fill the bath with a mixture of hot and cold water to prevent damage to Splashy.
- See section 11.6 for some guidance on how to position the recline arm on the Splashy.

### 11.2.1 Placement of the floorsitter

The floorsitter should always be placed on a firm, solid, static surface. When placing the floorsitter on your chosen surface, it's vital that all rubber feet are in contact with the surface.

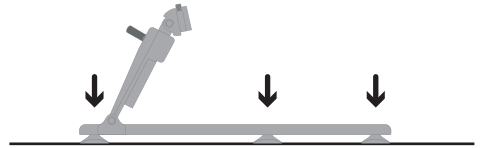

The rubber feet can be adjusted to facilitate curved baths. You can do this by rotating the feet clockwise or anti-clockwise depending on your required adjustment.

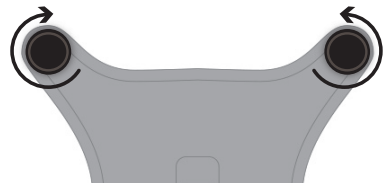

The rubber feet can be moved into the narrower section of the floorsitter to depending on the width of your bath. You must ensure they mirror each other. 4 or 6 feet would be stable.

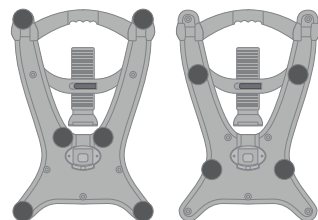

Continued →

### 11.2.1 Placement of the floorsitter

Once the floorsitter is in place, ensure the recline arm is set to its highest position.

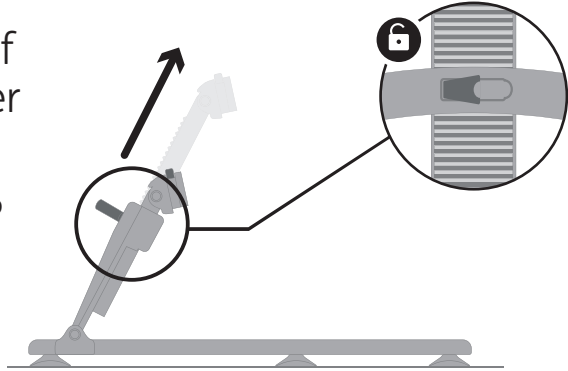

### 11.2.2 Assembling the Splashy seat

**1**

Before attaching Splashy to the floorsitter, the back rest and seat base must be assembled.

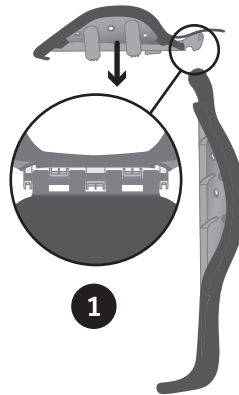

**2**

Hold the backrest of Splashy up vertically with the grooves at the top. Use your other hand to slot the seat base into the grooves on the backrest.

Flip the seat base in the opposite direction to lock the connection together. Once connected insert the hinge foam flap underneath the foam backrest cover.

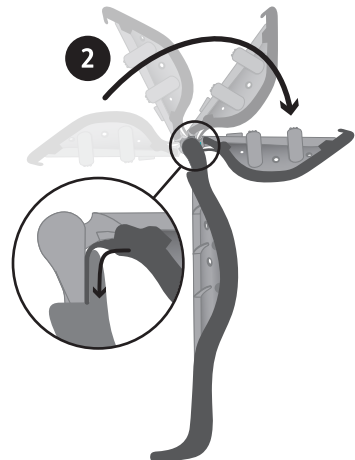

### 11.2.3 Attaching & configuring the harness & bumpers

- 1 To attach any of the support straps and bumpers onto Splashy's seat base and back rest place the relevant toggle through the hole.
- 2 Secure by turning the toggle sideways underneath the seat.

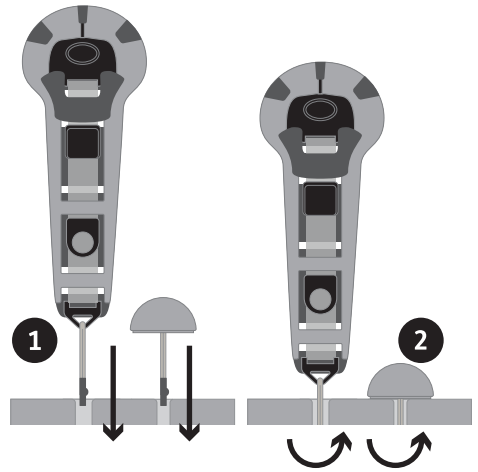

To connect the shoulder and lateral straps, follow this diagram.

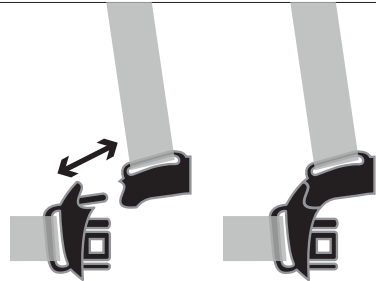

To ensure you are placing the straps in the correct side of Splashy, the buckle should appear as pictured.

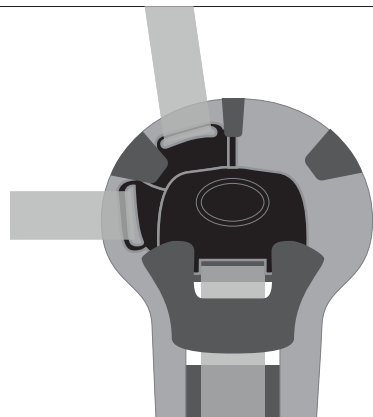



## 11.2.4 Configuring 5 point harness

- 1** Insert toggle of the groin strap into Splashy seat base.
- 2** Insert the toggle of the left shoulder strap through the hole at the correct height for your child.
- 3** Insert the toggle of the left lateral strap into a hole on the side panels of the back rest.
- 4** Repeat the process for the right shoulder and lateral straps.
- 5** Once all the straps are securely in place, connect all the straps together using the buckle to create a 5 point harness.
- 6** The straps can be fully adjusted by releasing the clamp, making the strap tighter or looser depending on requirements. Please ensure the clamp is closed once the strap has been adjusted.

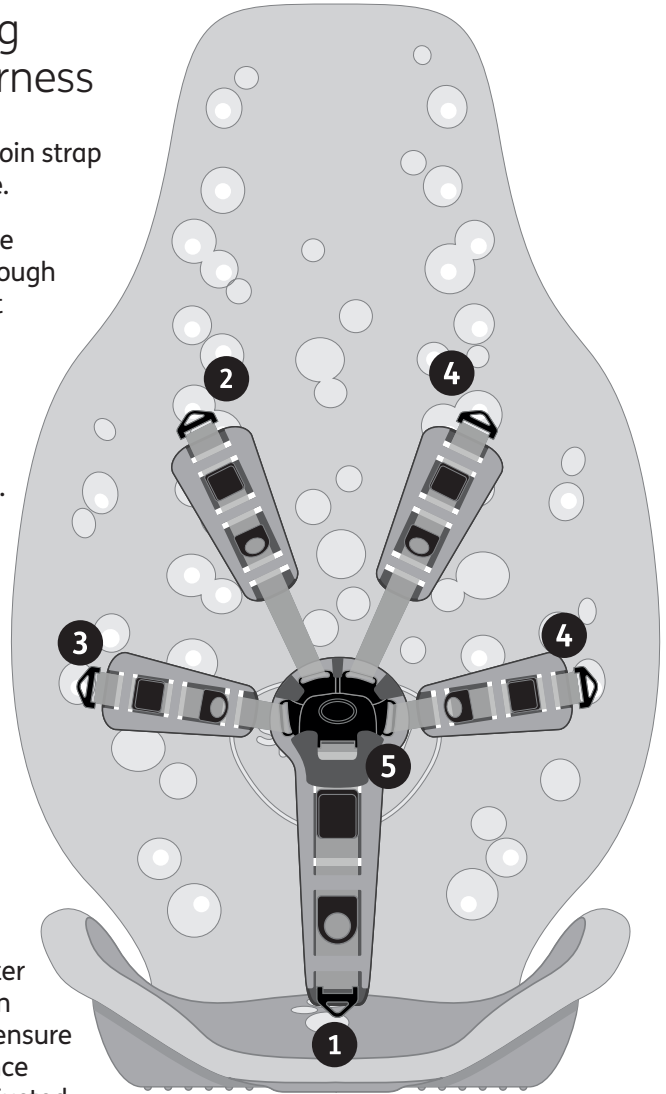

**Tip** – When happy with adjustment you can thread the remaining section of the strap through the foam section of the harness to keep it tidy.

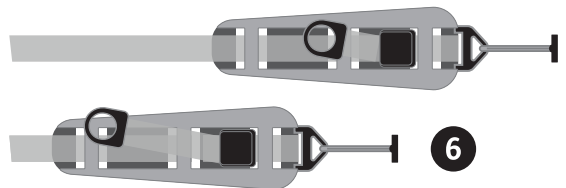

## 11.2.5 Configuring 3 point harness

- 1 Insert the toggle of the left lateral strap into a hole on the side panels of the back rest.
- 2 Repeat the process for the right lateral strap.
- 3 Once all the straps are securely in place, connect all the straps together using the buckle to create a 3 point harness.

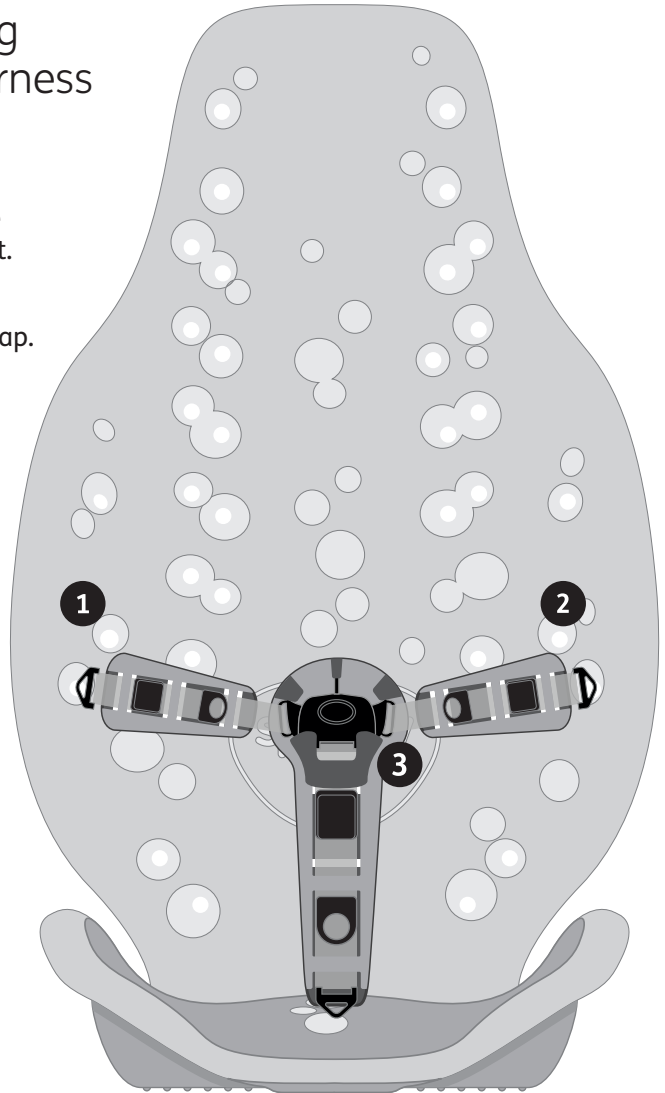

Do not adjust configuration from a 5 point harness to a 3 point harness while the child is in the bath seat.

## 11.2.6 Fitting Splashy seat to the floorsitter

- 1** Lower Splashy with the seat base flat onto the floorsitter.
- 2** Making sure the seat base is centrally aligned with the floorsitter move the seat base forward so the seat base slides into the locking channel.
- 3** When the seat base locks into the floorsitter you will hear a click which will mean the lock has been engaged.

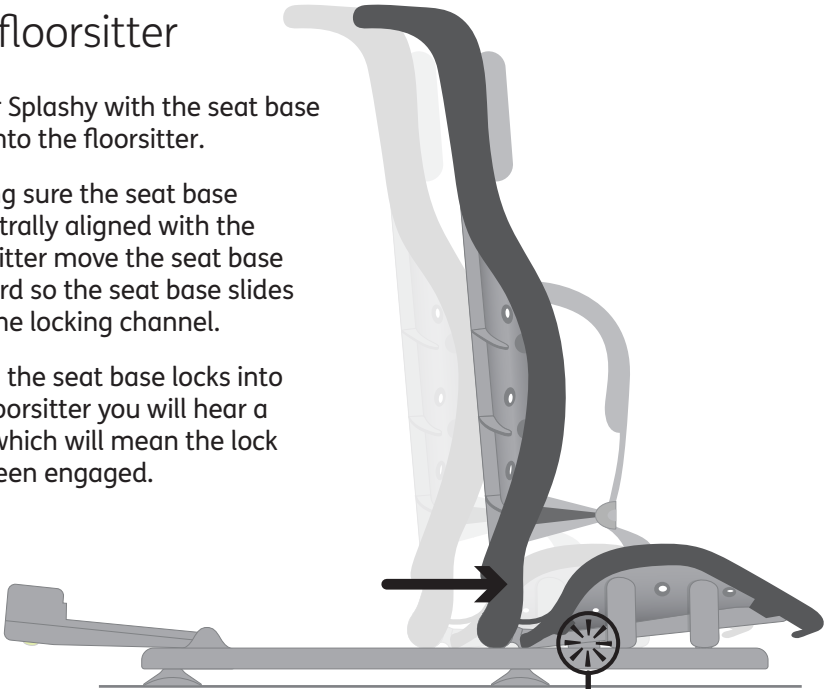



Listen for audible click when engaging both seat base and seat back to the floorsitter.



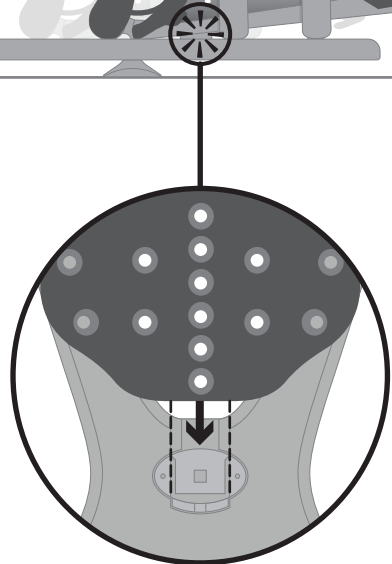

Before attaching the recline arm to the backrest, ensure that it is at the highest setting.

With one hand on Splashy, use the other hand to push the button highlighted and slot the attachment into the backrest.

Once attached correctly, you will hear a click.

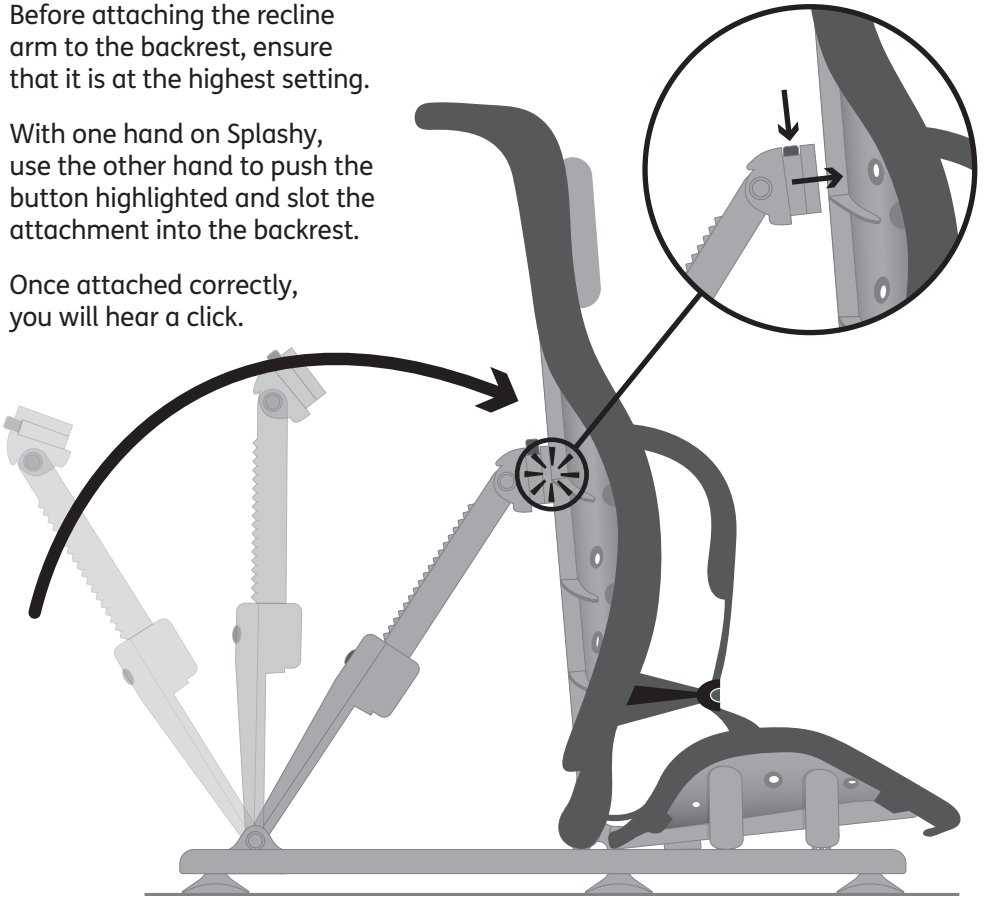

This picture shows what the bath seat should look like when it is fully assembled.

It is now safe to put your child into Splashy.

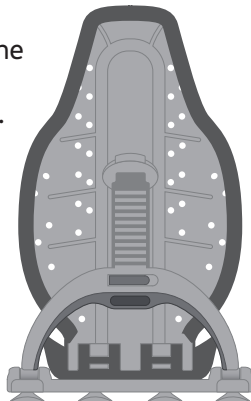

## 11.3 Bumper Supports

Once your child is safely secured in Splashy using the harness, you can then secure the bumpers to provide extra support.

The bumpers are being used as head supports in this picture, however they can be used as a pommel, anti-slide support and/or leg guides.

If you feel your child requires further support in Splashy, extra bumpers can be purchased from the Accessories section of the Firefly website.

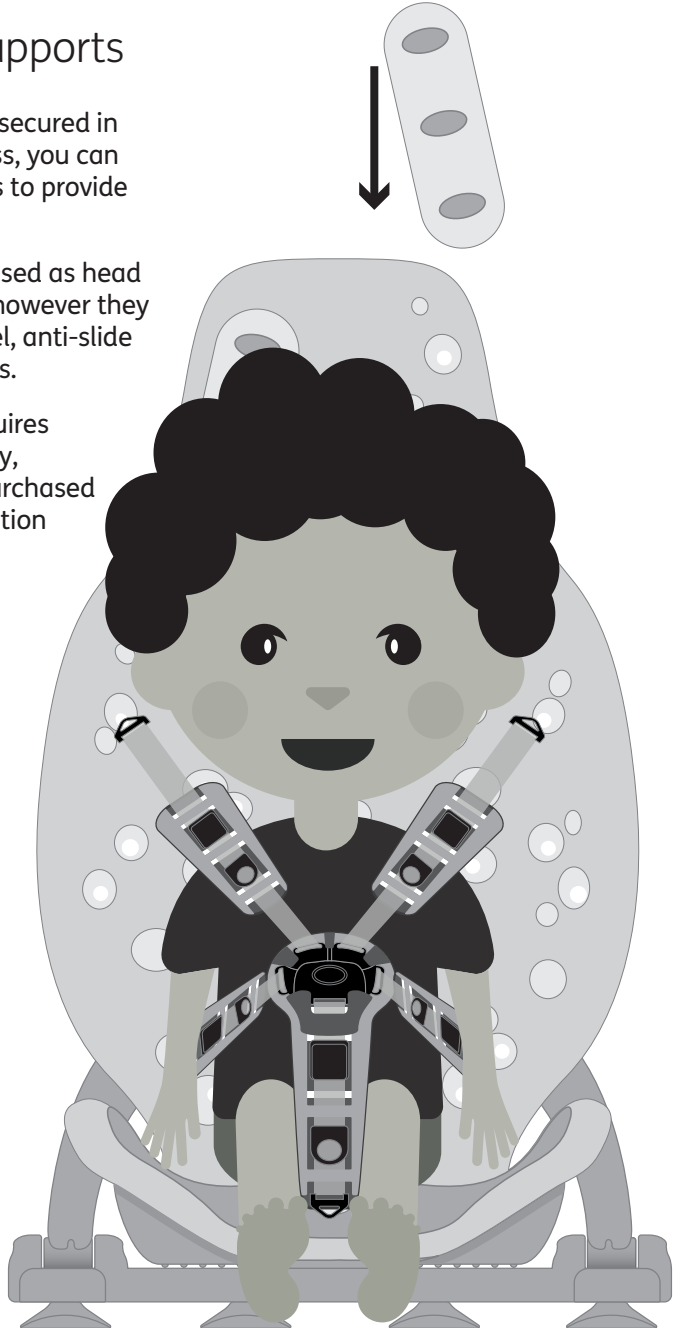

### 11.3.1 Adjusting the bumpers to provide support in various places

The bumpers can be used as:

**1. Head supports** – place a bumper on the right and left side of your child’s head.

---

**2. Neck support** – place a bumper sideways at the nape of your child’s neck.

---

**3. Pommel** – place a bumper between your child’s legs (helps to prevent criss crossing).

---

**4. Leg guides** – place a bumper on the right and left side of your child’s legs (helps to prevent them falling over the side of the bath seat).

---

**5. Anti-slide shelf** – place a bumper sideways on the base of the bath seat in front of your child’s bottom (helps to prevent your child’s bottom from sliding forward in the seat). Some children may find sitting in Splashy more comfortable if a bumper is placed in front of the groin strap.

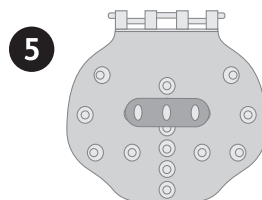
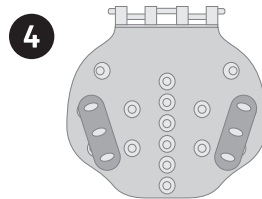
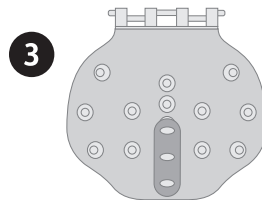
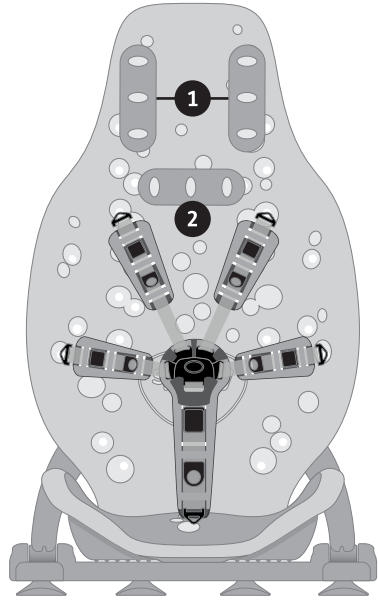

## 11.4 Adjusting the harness for washing

Remove a shoulder strap to make a 4 point harness to increase access for washing.

To remove the shoulder strap, release the toggle from the reverse of the backrest.

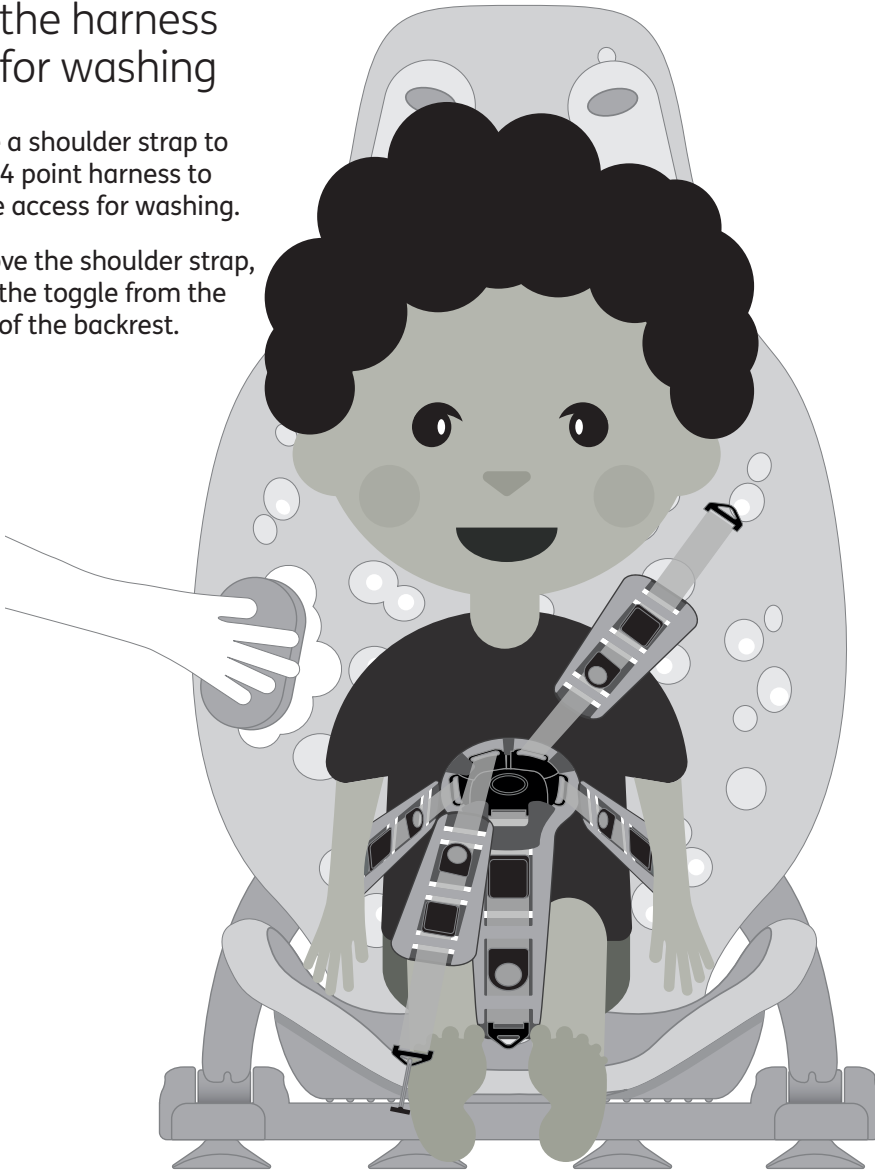

Remove a lateral strap to make a 4 point harness to increase access for lower half washing.

To remove the lateral strap, release the toggle from the reverse of the backrest.





## 11.5 Shortening lateral and shoulder straps

In some cases you may want to reduce the size of the lateral and shoulder supports to fit a smaller child using Splashy.

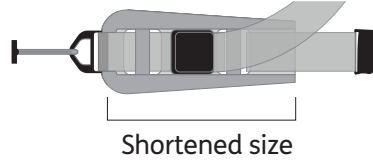
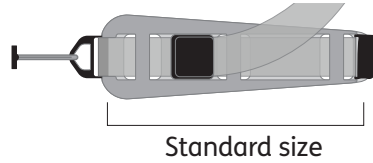

**1** When your Splashy arrives, the straps will look like the diagram shown. To adjust the straps to a smaller setting, please follow these instructions.

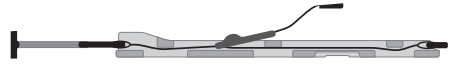

**2** Remove the highlighted section of the strap from the foam.

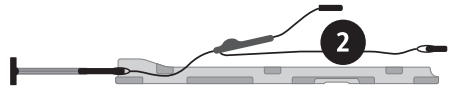

**3** Fold the thinner end of the foam backwards and ensure that the openings line up.

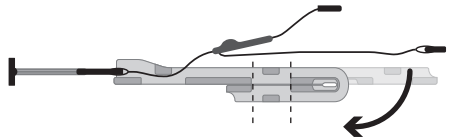

**4** Feed the straps through the first opening on the doubled over foam.

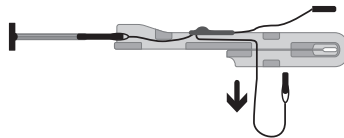

**5** Once it has been pulled through completely, feed up through the second opening and pull to tighten.

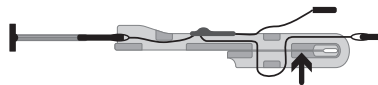

## 11.5.1 Shortening groin strap

In some cases you may want to reduce the size of the groin strap to fit a smaller child using Splashy.

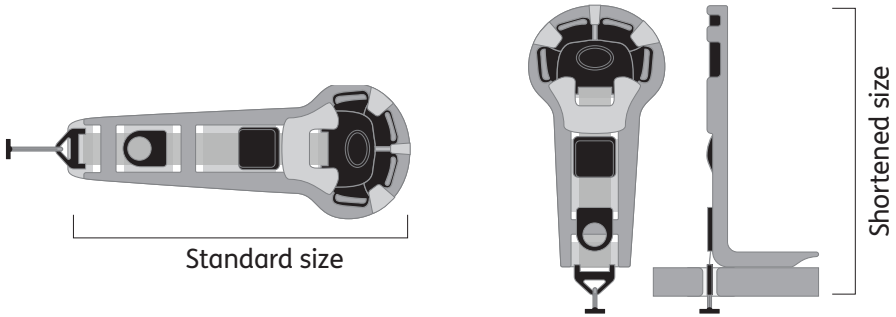

- 1** The groin strap will look as the diagram shows when it arrives. To adjust the straps to a smaller setting, please follow these instructions.
- 2** Remove the highlighted section of the strap from the foam.
- 3** Fold the foam backwards to create a smaller groin strap and feed toggle back through seat base hole.

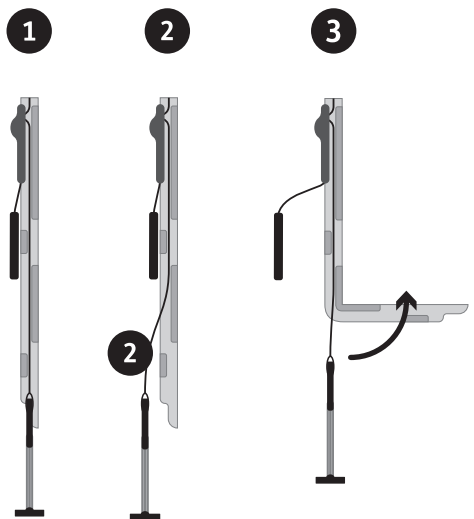

## 11.6 Recommended recline positions

---

**Upright position** – if your child has good sitting tolerance and trunk control, they may be able to use an upright sitting position.



**Mid recline position** – we recommend that Splashy is placed into a mid recline position if your child is being lifted into the bath seat.



**Full recline position** – we recommend that Splashy is placed into the full recline position for ease of transfer if your child is hoisted into the bath seat.

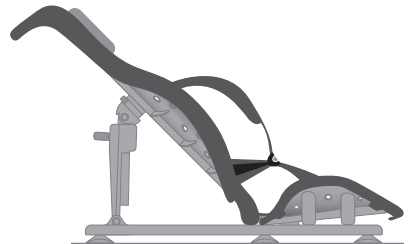

## 11.6.1 Using the Splashy recline function

Once your child is fully secure and supported, the Splashy recline function can be used.

Exercise caution when altering the recline angle. You should aim to make this movement as smooth as possible to reduce any anxiety the child may have.

To bring Splashy in to a more upright position, place one hand onto the Splashy handle **A** at the top of the backrest for support, and the other hand onto the green clip on the recline arm of the floorsitter. **B**

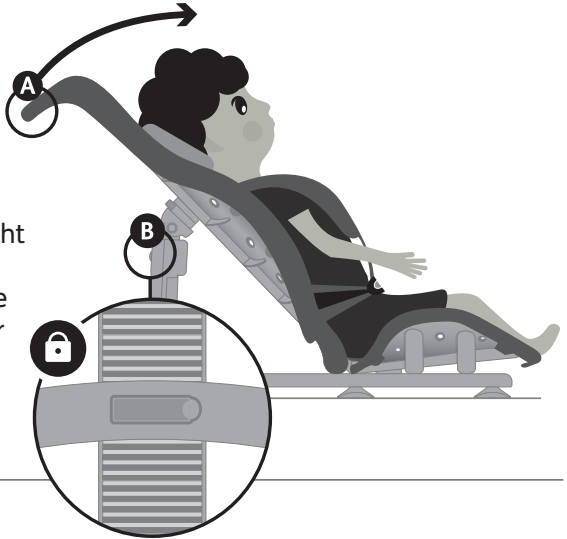

Release the clip and bring the bath seat into an upright position that is suitable for your child. **A**

Fasten the clip on the floor sitter. You will hear a click once fully engaged.

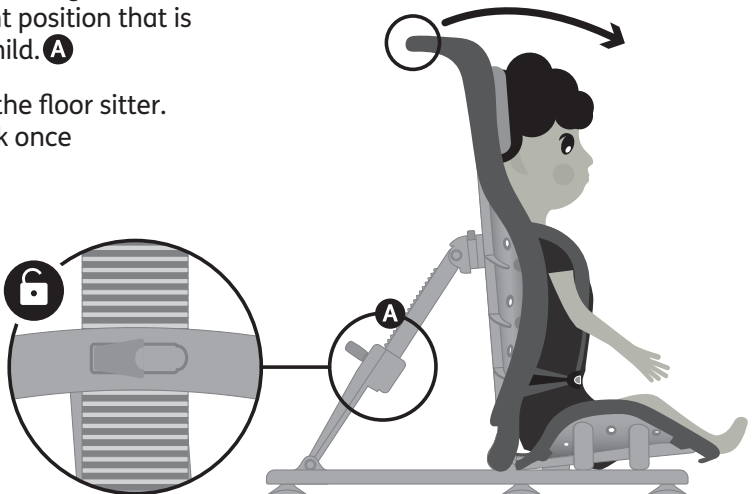

## 11.7 Removing Splashy from the bath after use and dismantling

Do not remove Splashy from the bath before disengaging seat base and floorsitter as this may put strain on the connections.

Release and remove the child from Splashy and drain the bath.



See Section 9 for guidance on how to do this safely.

To release Splashy from the floorsitter, press the green button on the recline arm and pull the back rest forward.

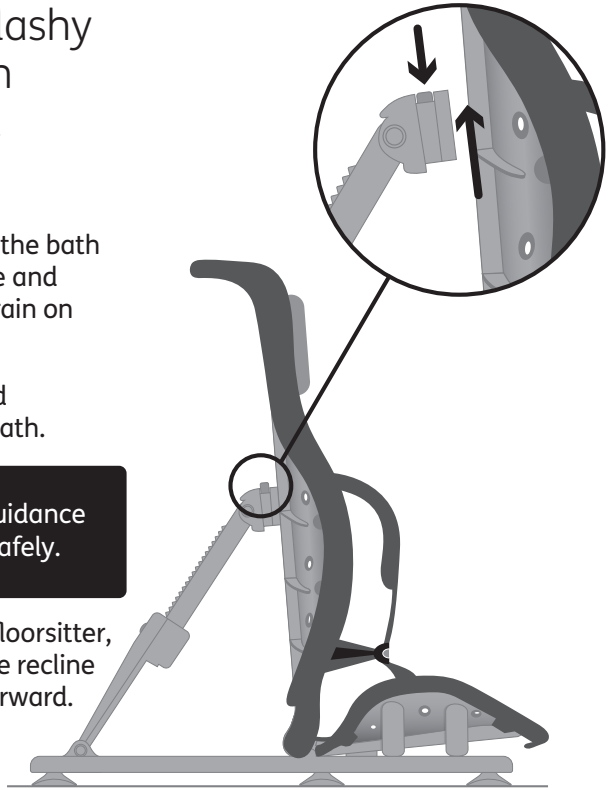

To release the seat base, pull on the green plastic tab **A** and slide backwards, then lift Splashy off the floorsitter. **B**

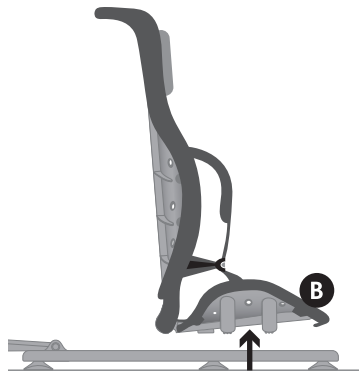
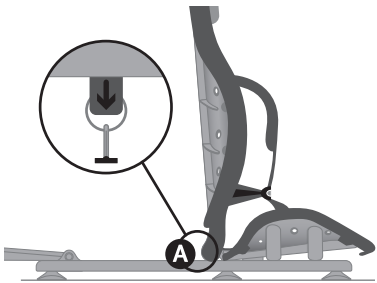

Ensure you do not force the frame from the bath as this may put strain on the connections.

To remove the floorsitter from the bath, gently slide your hand under the rubber feet and they will release.

**(do not use tools)**

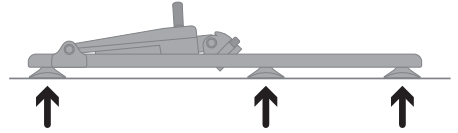

Place Splashy on its side and detach the seat base from the back rest by bending the seat base back on itself to release the hinge mechanism.

 Failure to follow these instructions may invalidate your warranty.

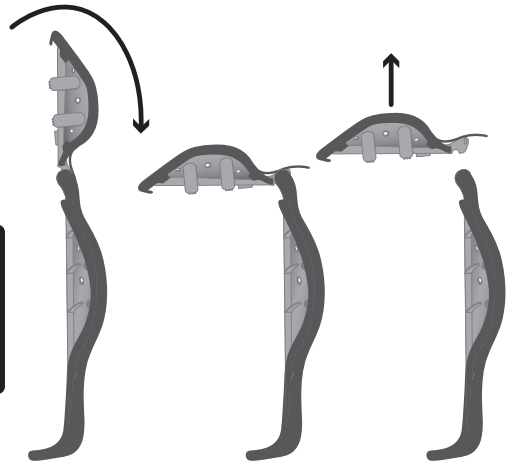

## 11.8 Draining and drying

Always ensure that you wipe/wash down Splashy before allowing it to drain and store away.

The floorsitter can be wiped dry. (Refer to Section 07 for further guidance.)

For drying purposes it may be easier to skip the last step in Section 11.7 and keep the seat base, back rest and floorsitter as one piece as per the example below.



For storing floorsitter when not in use, please slide recline arm down to lowest setting and lay flat as shown on step 2 below.

Press the green button on the recline arm and pull backrest forward to release seat.

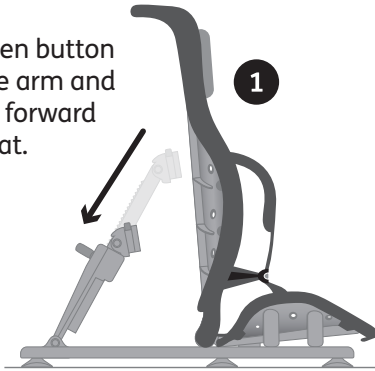

Fold recline arm forward as shown by the arrow.

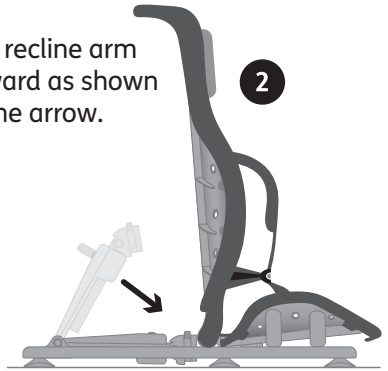

3

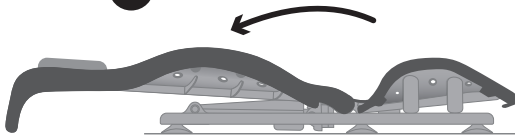

Recline the backrest onto the floorsitter as shown.

4

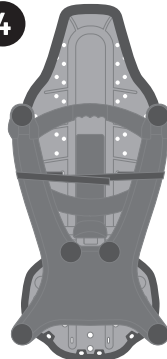

Use the velcro straps to keep the floorsitter flat against the Splashy seat.

## 11.9: Floorsitter Outdoor Feet

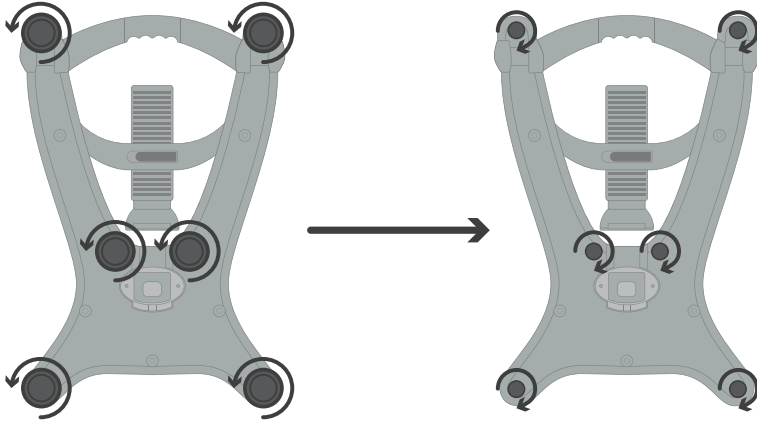

**1** Remove the 6 suction cup feet from the floorsitter.

**2** Add the outdoor feet by screwing in clockwise.

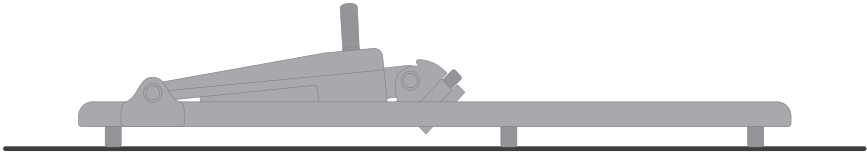

**3** Make sure all feet engaged and floorsitter is lying flat.















Do not use outdoor feet in the bath/shower. Please use original floorsitter suction cup feet.



## SECTION 12: Sizing Information

<b>Splashy technical information</b>	
<b>Seat back rest height</b>	610mm (24 inches)
<b>Seat back rest width</b>	385mm (15 inches)
<b>Seat base depth</b>	300mm (12 inches)
<b>Seat base width</b>	350mm (14 inches)
<b>Floorsitter width</b>	420mm ( 16.5 inches)
<b>Floorsitter height</b>	630mm ( 24 inches)
<b>Maximum weight</b>	30kg (66lbs)
<b>Age range</b>	1- 8 years old

## SECTION 13: Table of Symbols

Symbol	Meaning
	Medical Device
	Read the Instructions for Use
	CE mark
	UKCA mark
	Warning
	Manufacturer
	Product Code
	Serial number
	Max occupancy weight
	Date of Manufacture
	Latex free
	Unique Device Identification





**USA Distributor**

Sunrise Medical (US) LLC  
2842 N Business Park Avenue  
Fresno, CA 93727

**T:** 1-800-333-4000  
**F:** 1-800-300-7502  
**E:** [customseating@sunmed.com](mailto:customseating@sunmed.com)

[sunrisemedical.com](http://sunrisemedical.com)

**Canadian Distributor**

Sunrise Medical  
237 Romina Drive, Unit 3,  
Concord, ON, L4K 4V3

**T:** +1.800.263.3390  
**F:** +1.800.561.5834  
**E:** [mkt.canada@sunmed.com](mailto:mkt.canada@sunmed.com)

[sunrisemedical.ca](http://sunrisemedical.ca)

---

Fireflyfriends Ltd  
19c Ballinderry Road  
Lisburn BT28 2SA  
Northern Ireland

**T:** (+44) 28 9267 8879  
**E:** [hello@fireflyfriends.com](mailto:hello@fireflyfriends.com)



[fireflyfriends.com](http://fireflyfriends.com)

