

X320, X330, X340

Tricycle

X320, X330 & X340 Product Manual



Contents

Safety messages	3
Recommended use and item dimensions	4
Important information and check your order	5
Initial assembly instructions	
Attaching rear wheels	6
Attaching front end; Attaching seat and back	7
Rear end cap; Push handle	8
Rear steering handle	9
Caregiver brake	10
Basic item	
Parking brake; Variable pedal resistance	10
Pedals and Sandals	12
Seat; Backrest tilt	13
Components	
Trunk support system	14
Laterals; Headrests; Backrest pad	15
Handlebars; Handbrake; Hand anchor	16
Front guide bar; Mounting bar; Front basket	17
Abductor; Adductor	18
Pelvic harness	19
Stationary stand; Pedal raise kit	20
Operation	21
Maintenance; Cleaning	22
Warranty; Materials; User modifications	23

WARNING



- Thoroughly read and understand the information in this product manual before attempting to use this product. If the procedures and instructions in this product manual are not followed, serious injury or death could occur.
- A qualified professional must assess the appropriateness and safety of all equipment for each user.
- This product is intended for use by clients of unreliable judgment. Adult supervision is required at all times.
- To prevent falls and injuries:
 - Do not use this product on rough and uneven terrain, around swimming pools, or near stairways.
 - Ensure the appropriate use of straps and supports at all times. Straps and supports are provided for the safety of the user and must be carefully adjusted for comfort and security.
 - Tighten all adjustment knobs before use and immediately after making any adjustments.
 - Fasten all safety belts.
 - Do not use the Rifton Tricycle for clients with strong involuntary movements, poor body balance, or limited head control.
 - To prevent injury, user should always wear footwear and a protective helmet.
 - Keep hands away from sprockets, pedal crank and drive belt when user is on trike.
- To prevent falls, strangulation, head entrapment or other injuries:
 - Always use seat belt or pelvic harness when the butterfly harness, chest strap, or headrest are in use.
- Do not use this product for clients outside the height and weight limits specified in this manual.
- To prevent structural failure, which may result in serious injury or death:
 - Inspect this product and components regularly for loose or missing screws, metal fatigue, cracks, broken welds, missing attachments, general instability or other signs of excessive wear.
 - Immediately remove this product from use when any condition develops that might make operation unsafe.
 - Do not use Rifton components or products for any purpose other than their intended use.

Recommended use

The Rifton Tricycle is a Class 1 medical device. It can be used for therapeutic reciprocal exercise for maintaining range of motion and strength, or for recreational purposes for children and adolescents with disabilities. The belt drive from the pedals to the rear wheel offers the following advantages:

- Pedaling is slightly forward of the seat instead of at the front wheel as with many other tricycles. This provides a more efficient, comfortable and natural posture.
- Steering is separate from pedaling, reducing the coordination needed to pedal and steer the tricycle.

User and item dimensions

User dimensions – inches (cm)	X320 small	X330 medium	X340 large
Inside leg length	12*–22 (30*–56)	19–28 (48–71)	25–38 (64–97)



Key user dimension: inside leg length

The extended leg should reach from seat to pedal comfortably when both feet and torso are strapped into place.

Important: User’s weight must not exceed the maximum working load. Rifton Tricycles are not intended for children with strong reflexes or poorly developed trunk balance and head control. Consult your client’s therapist before ordering.

Item dimensions – inches (cm)	X320 small	X330 medium	X340 large
Overall width	25½ (65)	27½ (70)	31½ (80)
Overall length	44 (112)	53 (135)	65 (165)
Overall height (at lowest position with wheels / front end removed for transport)	21¼ (54)	21¼ (54)	30 (76)
Overall length with no rear handle (wheels and front end removed)	36 (91)	41 (104)	49 (124)
Overall length with rear handle (wheels and front end removed)	48 (122)	51 (130)	60 (152)
Wheel diameter	12 (30)	15 (38)	18 (46)
Seat center to extended pedal	12*–22 (30*–56)	19–28 (48–71)	25–36 (64–91)
Seat to top of trunk support (max height)	16 (41)	24 (61)	24 (61)
Adjustment range of laterals	small trunk support: 6–12 (15–30)	small trunk support: 6–12 (15–30) large trunk support: 9½–15½ (24–39)	large trunk support: 9½–15½ (24–39)
Gear ratio	1:1	1:1	1:1
Basic item weight – lbs (kg)	47 (21)	56 (25)	65 (29)
Max. working load – lbs (kg)	125 (57)	250 (113)	310 (140)

*14" (36) minimum with medium seat installed on small trike

IMPORTANT

Please save this product manual for future reference. Additional copies are available at www.rifton.com/customer-service/product-manuals.

Key for users

Use this key to determine which sections of this product manual apply to you.

 **Technical Users** For professionals who order and set up Rifton products.

 **Home Users** For caregivers who use Rifton products on a regular basis.

 **Maintenance Personnel** For anyone who is responsible for service or re-ordering of Rifton products and parts.

Check your order

Tricycle main frame, front end assembly, seat, backrest assembly, components, and this product manual ship together.

You may not have ordered all of the available components, but use the diagrams that follow to confirm that your order is complete.

If your shipment is incomplete or in any way damaged on arrival, please call Customer Service, 800.571.8198.

Initial assembly instructions

Parts included in hardware kit*

1. Two quick release pins (not in small Trike hardware kit)
2. Two 3/16" hex keys
3. One bolt
4. One nut

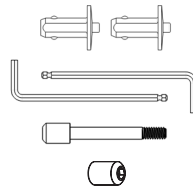

*One 5/16" hex key included with small Trikes for seat depth adjustment (see p. 13)



Scan the QR code or visit www.rifton.com/trikeassemblyvideo to watch the trike assembly video.

Attaching rear wheels (medium and large Trikes only)

⚠ WARNING To prevent tipping, ensure quick release pins are fully inserted with buttons extended. Check to make sure each wheel is secure before using tricycle.

Note: Before installing or removing the rear wheels, ensure that the parking brake is fully released (variable resistance set to zero).

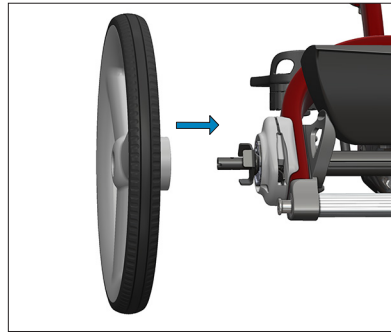

Figure 6a

Installing rear wheels

Figure 6a: Slide both rear wheels onto axle. Push inward on both wheels to ensure axles extend to outside of wheel hubs as shown in Figure 6b before installing quick release pins.

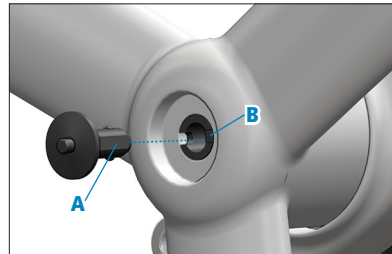

Figure 6b

Installing quick release pins

Figure 6b: Match flat side (A) of quick release pin (provided in hardware kit) to flattened tab in the axle (B) and then install quick release pin. Repeat on the opposite wheel.

Figure 6b: Axle ends must be flush with the wheel hubs.

Figure 6c: Quick release pins must be fully inserted with buttons popped out.

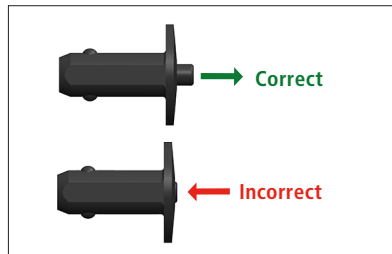

Figure 6c

Attaching front end (medium and large Trikes only)

⚠ WARNING To prevent injury to the rider or damage to the product, ensure quick release pin is fully inserted with the button extended prior to use.

Note: Adjust the handlebar to the upper end of its range, and set the brake to PARK (see page 11) before attaching front end.

Figures 7a and 7b: Align the holes in the front end assembly with the holes in the head tube, push the button (A), and install the release pin through the bottom plate of the front end assembly, ensuring that it goes all the way in. You may need to lift on the handlebar to align the holes properly.

Figure 7b: Button on quick release pin (A) must pop out to latch.

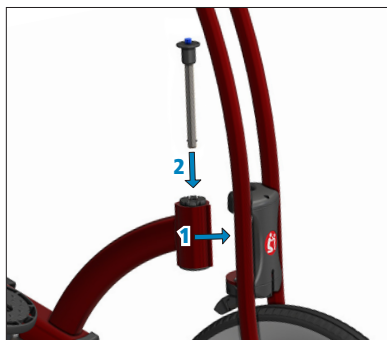

Figure 7a

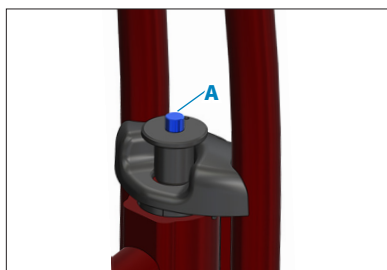

Figure 7b

Attaching seat and back (medium and large Trikes only)

Figure 7c: Lift the backrest and insert the backrest recline adjustment stamping (B) into the plastic slot as shown. Raise the adjustment pin (C) and make sure the pin inserts into one of the holes in the stamping.

Figure 7d: Slide the seat and backrest assembly onto the height adjustment track and carefully lower it fully by pressing the seat height adjustment trigger (D) on Figure 7c).

Tip: Make sure the black plastic glides (E on Figure 7d) are pushed to the outside of the seat bracket before sliding the assembly onto the seat adjustment track.

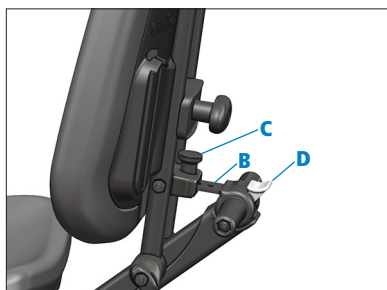

Figure 7c



Figure 7d

Initial assembly instructions, cont.

Rear end cap (all Trike sizes)

Must be installed if no rear handle is selected at purchase

⚠ WARNING To prevent falls, component must be installed with nut and bolt tightened to a hard stop before use.

Attaching (Use the hardware and tools provided in the included kit.) **Figure 8a:**

1. Insert the rear end cap (A) into the tube as shown.
2. Insert the bolt through hole (B), insert the nut in the opposite hole, and tighten the nut using the hex keys provided. **Be sure to fully tighten nut and bolt to a hard stop.**

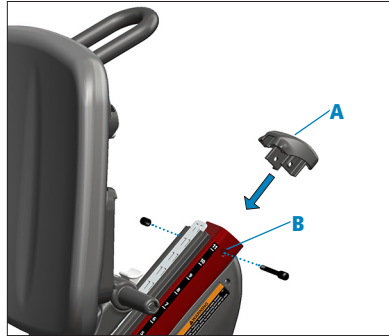

Figure 8a

Push handle (all Trike sizes)

If selected at time of purchase

⚠ WARNING To prevent falls, component must be installed with nut and bolt tightened to a hard stop before use.

Attaching (Use the hardware and tools provided in the included kit.) **Figure 8b:**

1. Insert handle into the tube as shown.
2. Insert the bolt through hole (C), insert the nut in the opposite hole, and tighten the nut using the hex keys provided. **Be sure to fully tighten nut and bolt to a hard stop.**

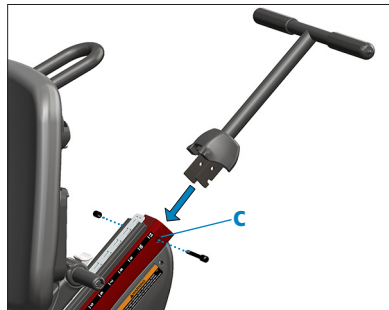

Figure 8b

Rear steering handle (all Trike sizes)

If selected at time of purchase

⚠️ WARNING To prevent falls, component must be installed with nut and bolt tightened to a hard stop before use.

Attaching (Use the hardware and tools provided in the included kit.) **Figure 9a:**

1. Insert handle into the tube as shown.
2. Insert the bolt through hole (A), insert the nut in the opposite hole, and tighten the nut using the hex keys provided. **Be sure to fully tighten nut and bolt to a hard stop.**

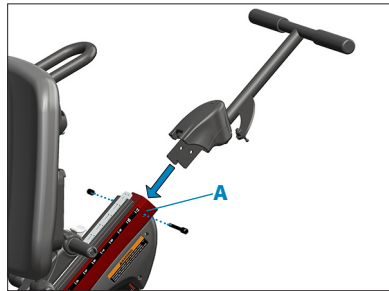

Figure 9a

Rear steer rod attaching

For large and medium Trikes only:

1. **Figure 9b:** Slide the locking collar down, and connect the front socket joint (B) onto the front ball joint.

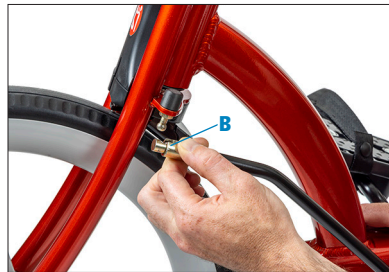

Figure 9b

For all Trike sizes:

2. **Figure 9c:** Slide the locking collar down, and connect the rear socket joint (C) onto the rear ball joint.

For large and small Trikes only:

3. **Figure 9d:** Use the pin (D) to attach the straight section of the rod (E) to the rear slot in the steering linkage under the seat.



Figure 9c

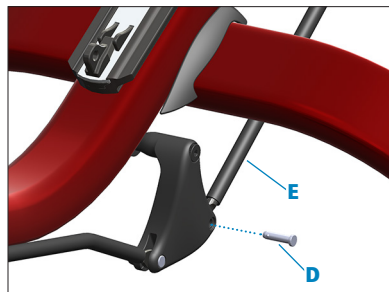

Figure 9d

Caregiver brake (all Trike sizes) If selected at time of purchase

Attaching the cable

1. Set the parking brake in the PARK position (see page 11).
2. **Figures 10a and 10b:** Hook the ball end of the cable into the slotted metal bracket (A) within the parking brake housing, and lift the cable conduit up into the pocket in the brake housing (B) as shown.

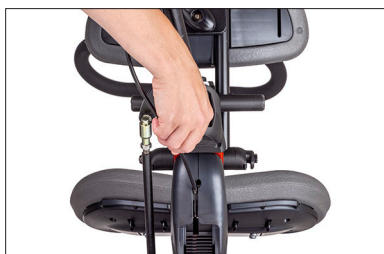

Figure 10a

Basic item

Parking brake

Figure 10c: The parking brake locks the rear wheels to hold the tricycle in place. It is for use on level surfaces only. To activate the brake, pull the brake handle (A) all the way up to align the indicator (B) with the PARK position. To release the brake, press the white button (C) and lower the handle.

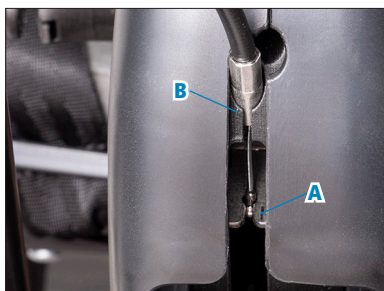

Figure 10b

Variable pedal resistance

Figure 10c: The variable resistance feature allows drivetrain resistance to be increased. To raise the resistance, lift the brake handle (A) to align the indicator (B) with the desired resistance level. To lower or release the resistance, press the white button (C) and lower the handle.

Adjusting the variable resistance and parking brake

Figure 10c: To increase the variable resistance and parking brake force, turn the adjusters (D) out (counterclockwise). To reduce the variable resistance and parking brake force, turn the adjusters in (clockwise). For best results, both adjusters should be adjusted a similar distance from the parking brake assembly.



Figure 10c

Both wheels should spin freely when the parking brake lever is set to zero and keep the tricycle stationary when the lever is set to PARK.

Balancing the rear brake system

Figure 11a: If one rear brake is rubbing, or the caregiver brake is not working properly, the resistance and parking brake system may need to be re-balanced.

1. Set parking brake handle (A) to PARK. Unhook caregiver brake cable if present (See p10). Then release parking brake lever to zero position.
2. Loosen (clockwise) or tighten (counterclockwise) the adjuster (B) on the cable attached to the right-hand rear wheel brake until the right rear wheel is just spinning freely from the brake.
3. Set parking brake to PARK and then release.
4. Check to make sure both wheels are just spinning freely. If there is still resistance, repeat Step 2. and then cycle the parking brake again according to Step 3. Note: The drive wheel may seem to have more resistance because it is connected to the front crankset through the sprockets and drive belt. This is normal and does not require balancing the system.
5. Reattach caregiver brake cable if present (see p10). Check that both rear wheels just spin freely. Fine-tune adjuster nut on caregiver brake as necessary (clockwise for less resistance, counterclockwise for more resistance).



Figure 11a

Pedals/Sandals

Figure 12a: Sandals and leveling rope (A) can be completely removed, leaving a conventional bike pedal underneath. Unhook the leveling rope loops from the backs of both pedals, pull them through the holes in the sandals, and unclip the quick release pulley from the metal loop at the base of the seat track. Remove knobs (B) and pull the sandals off.

To reattach the sandals, clip the quick release pulley to the metal loop at the base of the seat track, then thread the leveling rope through the hole in the back of the sandal and hook it onto the back of the pedal. Line up the holes in the pedal with the slots in the sandal and insert the bolts. Thread the knobs onto the bolts, adjust the sandal to the correct position, and tighten the knobs securely.

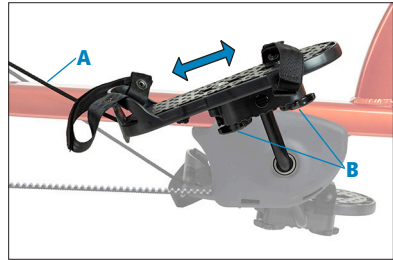

Figure 12a

Sandal adjustments

Figure 12a: Loosen knobs (B) to slide the sandal forward and backward on its pivot point for adjusting the sandal heel stop and foot length. Moving the sandal back compensates for plantar flexion. The leveling rope (A) compensates for dorsiflexion.



Figure 12b

Figure 12b: Sandal straps can be unsnapped and moved to any position around the pedal, or removed completely.

Seat

⚠ CAUTION

To avoid back injury, use caution when adjusting the seat height with a user on the seat.

Seat height

Figure 13a: Brace your foot on the gray bar between the back wheels of the trike. With both hands on the handle, press trigger (A), and move the handle up or down to adjust the seat height. Only adjust the seat height with a user on the seat if you can safely support their weight.



Figure 13a

Seat depth

Figure 13b: Loosen knob (B) to adjust the position of the seat forward or backward to change the distance relative to the backrest pad.

Note: Adjusting the seat depth on a small Trike requires a 5/16" hex key.



Figure 13b

Backrest tilt

Figure 13c: Pull up on knob (C) to adjust the backrest angle to 0°, 7½°, or 15°.

Note that the backrest can also be released fully and folded forward for transport.

Quick release rear wheels

See page 6 for instructions.

Quick release front end

See page 7 for instructions.

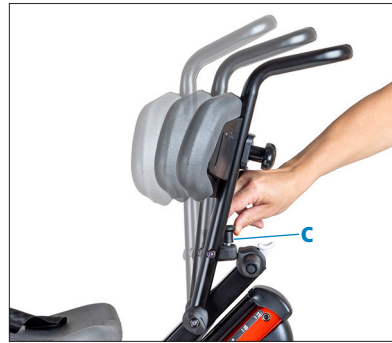

Figure 13c

Components

Trunk support system

⚠ WARNING To prevent falls, strangulation, head entrapment or other injuries:

- Always use the seat belt or pelvic harness when butterfly harness or chest strap is in use.
- Ensure correct adjustment and positioning of the butterfly harness at each use.
- Tighten the lower straps of the butterfly harness before tightening the upper straps.

Recommended use

The trunk support system aids users who have difficulty remaining upright while sitting. It provides the attachment points for the butterfly harness, laterals, and headrest options, which help the user maintain head control, posture, and good positioning.

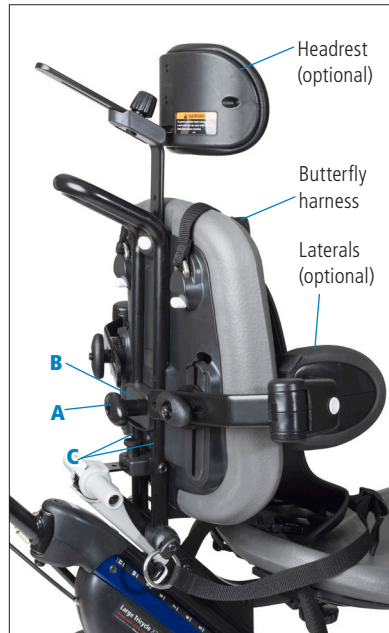

Figure 14a

Attaching trunk support

Figure 14a:

1. Loosen the knob (A).
2. Rotate the clamp (B) to pass between the tubes (C) in the position shown.
3. Rotate the clamp again to align the cradles with the tubes, adjust to the desired height, and tighten the knob securely.

Butterfly harness

Figure 14b: Clip on butterfly harness using the ring attachment points. The small rings (D) clip into the top slots, and the large rings (E) clip into the bottom slots. Adjust the lower straps first, followed by the upper straps.

Note: Refer to page 13 for seat height and depth adjustments, and backrest tilt adjustment.



Figure 14b

Laterals

Figure 15a:

1. Loosen the knob (A) and insert the metal key into the slot (B) behind backrest. Adjust the height, width, and angle of the lateral, then tighten knob securely.
2. Push the lateral release button (C) and swing lateral out or in.

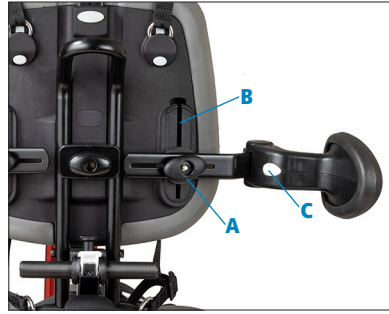

Figure 15a

Headrests

Figure 15b: Two headrests are available for use with the trunk support system only: Contoured and winged

Attaching:

Figure 15c: Press white oval button (D) and insert metal headrest bar into slot. Release the white button to set headrest height.



Figure 15b

Adjusting:

Press white oval button (D) and raise or lower headrest. Release button to engage and click into place. To adjust depth of headrest, loosen black knob (E). Move headrest to desired position and tighten knob securely.



Figure 15c

Backrest pad

Attaching:

Figure 15d:

1. Loosen the knob (F).
2. Rotate the clamp (G) to pass between the tubes (H).
3. Rotate the clamp again to align the cradles with the tubes, adjust to the desired height, and tighten the knob securely.



Figure 15d

Handlebars

Figures 16a and 16b: A conventional handlebar or loop handlebar can be used with your Rifton tricycle.

Adjusting the handlebars:

Figure 16a: The handlebar height adjusts with knob (A). Rotate the handlebar toward or away from the rider by loosening the knob (B).

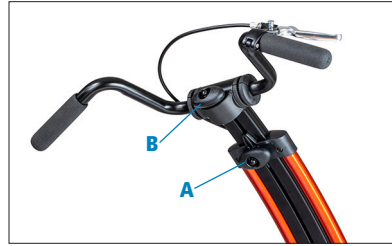

Figure 16a (conventional handlebar)

Front handbrake

Figure 16c: The front handbrake allows the user to slow and stop the tricycle. It is equipped with a brake lock. Squeeze the brake handle (C), and press the button (D) in to lock the brake. Squeeze the brake handle to unlock.



Figure 16b (loop handlebar)

Adjusting

Figure 16c: To move the handbrake position, loosen the attachment clamp (E) using a 5 mm hex key. The handbrake can be rotated, or moved to a right or left-handed position.

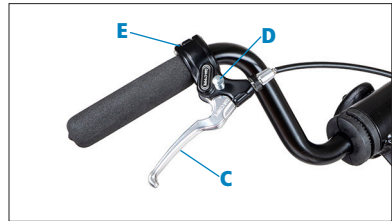

Figure 16c

Hand anchor Figures 16d and 16e:

Note: The hand anchor works best with the loop handlebar.

Attaching:

1. Secure one end of the hand anchor around the user's wrist.
2. Place user's hand on the handlebar.
3. Wrap the hand anchor securely around the handlebar and the user's hand.
4. Secure the other end around the user's wrist.



Figure 16d



Figure 16e

Front guide bar

⚠ CAUTION

Remove the front guide bar from the trike when not in use.

Figure 17a: The front guide bar allows the caregiver to guide and move the tricycle from the front.

Attaching:

Figure 17a: Raise the handlebar from its lowest position.

1. Loosen knob (A) as far as it goes to open the clamp.
2. Attach the front guide bar to the handlebar as shown.
3. Tighten knob (A).



Figure 17a

Mounting bar **Figure 17b:**

The mounting bar is compatible with most standard bicycle handlebar device holders.

Attaching:

1. Loosen knob (B) and engage the mounting bar with the slots (C) at the top of the handlebar pivot as shown, then tighten knob.

Note: The mounting bar can be oriented with the bar centered between the handlebars as shown or pointing to the left or right, as desired by the user.

2. Rotate to desired position by loosening knob (B).



Figure 17b

Front basket

Figure 17c: To attach the front basket, slide the basket hooks over the upper headset crossbar (D) as shown.

Note: Adjust the handlebar up from lowest position prior to attaching the basket.



Figure 17c

Abductor

Recommended use:

The abductor is for clients who require knee separation or abduction.

Attaching:

Figure 18a: Slide the abductor support tube (A) into the end of the seat support tube, then tighten knob (B).

Note: The tube has indexed markings. Ensure that the abductor bar does not exceed the highest number on the abductor support tube before tightening the knob.



Figure 18a

Abductor with adduction straps

Recommended use:

Figure 18b: The abductor with adduction straps limits lateral movement of the user's knees, providing a comfortable lateral boundary.

Attaching:

Figure 18b: Slide the abductor support tube (A) into the end of the seat support tube, then tighten knob (B).

Note: The tube has indexed markings. Ensure that the abductor bar does not exceed the highest number on the abductor support tube before tightening the knob.

Adduction straps clip onto the rods (C). Attach the straps around the client's thighs and adjust them to fit.



Figure 18b

Pelvic harness



WARNING To prevent falls, strangulation, head entrapment or other injuries, always use seat belt or pelvic harness when the butterfly harness is in use.

The pelvic harness may be used in place of a seat belt as the primary means of securing a user in the trike. This alternative to the more typical seat belt gives a stable base for developing sitting postural control. The pelvic harness firmly positions the user's pelvis by securing hips and upper thighs without putting pressure on the abdomen.

Attaching

Note: the small seat has only one slot and ring per side. If both seat belt and pelvic harness are in use, the single slot and ring should be shared by both.

1. **Figure 19a:** To attach the pelvic harness, place it on the seat with the wide ends towards the back of the seat and the strap attachment pointing down.
2. Thread the triangular clips (A) through the outer slots (B) at the back of the seat.
3. Clip them to the outer attachment rings (C) under the seat and screw the rotating nuts to close the clips.

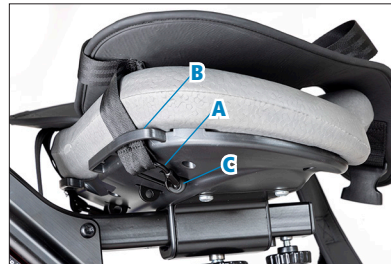

Figure 19a



Figure 19b

Adjusting

Figure 19b: With the harness pad flat on the seat, position the client. Pull each end of the pad up between the client's legs and over the near leg (e.g., left pad end over the left leg). Secure the buckles (D). Tighten the straps as necessary.

Stationary stand

⚠ WARNING To prevent falls and injury, always use the correct notch depending on the size of the trike.

Recommended use:

Figure 20a: The stationary stand converts your tricycle into a stationary trainer for learning the basic motions of pedaling.

Tip: The variable resistance feature works well with the stationary stand.

Attaching Figure 20a:

1. Place the stands (A) on the floor in the desired location.
2. Lift the rear end of the tricycle and place the gray protrusions (B) into the correct notch on the stands. Use the lowest position for the X320 (small), the middle for the X330 (medium), and the highest for the X340 (large) Rifton Tricycle.



Figure 20a

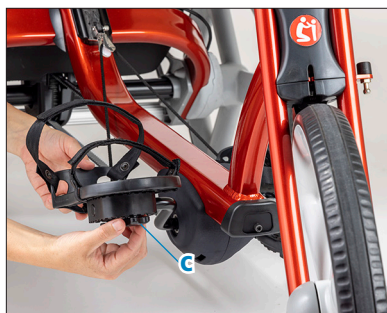

Figure 20b

Pedal raise kit

Attaching:

1. **Figure 20b:** Take off the sandal by removing the two knobs (C) underneath.
2. **Figure 20c:** Remove the bolts from the sandal and install the longer bolts provided in the pedal raise kit.
3. **Figure 20c:** Slide one or two of the pedal raise blocks (D) onto the bolts on the sandal. Each block raises the pedal by ½" (1 cm).
4. **Figure 20d:** Re-install the sandal onto the pedal and tighten the knobs underneath.



Figure 20c



Figure 20d

Operation

Adjust seat height so that the distance from seat to foot pedal approximates the key user dimension of the client's inside leg length. The client's extended leg should reach comfortably from seat to pedal when both feet and torso are strapped into place.

Approximate the height of the trunk support system so it is appropriate for client's seat to shoulder height (or adjust backrest height if used). Approximate the best position for the handlebar, and make sure the handlebar is out of the way prior to transfer. Make sure the straps on the foot pedals are open and ready for feet placement. Set the brake in the PARK position.

Assist client to transfer to a seated position on the tricycle seat, and secure the seat belt immediately when client is seated.

Finalize positioning adjustments for trunk support system and handlebar. Add and adjust further components as needed: i.e., the support laterals and butterfly harness of the trunk support system (or backrest pad strap if used), the headrest, the abductor, and sandal straps.

Maintenance

This product is designed and tested for an expected life of 5 years when used and maintained in accordance with this manual. At all times, users must ensure that the product remains in a safe and useable condition, including regular maintenance and inspections as specified in this manual.

The parking brake is factory adjusted for optimum performance when new. It may need periodic adjustment to compensate for system wear. See page 11 for instructions.

To prevent structural failure, which may result in serious injury or death:

- Inspect this product and components regularly for loose or missing screws, metal fatigue, cracks, broken welds, missing attachments, general instability or other signs of excessive wear.
- Immediately remove this product from use when any condition develops that might make operation unsafe.
- Do not use Rifton components or products for any purpose other than their intended use.
- Replace or repair components or products that are damaged or appear to be unstable.
- Use only Rifton authorized replacement parts. Order information for replacement parts is provided on the back of this product manual.

Cleaning

The trike can be cleaned with disinfectant wipes or a solution of up to 10% bleach. Do not use excessive amounts of water. This includes metal parts, upholstery, harness, and padded straps. You may also use a commercial cleaning agent suitable for imitation leather for the upholstery.

Do not machine wash harness or padded straps.

The sandal straps, seat belt and chest belt may be machine washed. Engage the hook and loop closures before washing. The adduction straps and hand anchors may be machine washed with cold water and air dried. Do not iron.

Warranty statement

If a Rifton product breaks or fails in service during the first year, we will replace it free of charge.

Materials

- Steel hardware items (nuts, bolts, screws, etc.) are typically zinc or nickel plated, or stainless steel.
- Upholstery items (abductor, headrests) are polyurethane foam with a fire-retardant cover.
- Seat pads and other padded supports are made of polyethylene foam.
- Frames are typically steel or aluminum tubing, welded together, and coated with a baked-on paint finish. Some frame components may also be stainless steel.
- Tires are tubeless, filled with polyurethane foam, and do not require inflation.
- Straps are typically made of polypropylene or nylon webbing.
- Plastic components are typically injection molded from a variety of industrial resins.

All materials are latex, lead and phthalates free.

User modifications

⚠️ WARNING To prevent serious injury or death, do not modify or alter Rifton products or components, or use Rifton products or components in conjunction with products from other manufacturers. Rifton does not accept responsibility for any modifications or alterations made to our components or products after they leave our premises. Customers modifying or altering our components or products, or using them in conjunction with products from other manufacturers, do so at their own risk.

Rifton Contact Information



Email

Sales@Rifton.com



Phone

800.571.8198

9–5 EST



Mail

Rifton Equipment
PO Box 260
Rifton NY 12471–0260



Fax

800.865.4674



Online

www.Rifton.com

To order replacement parts

1. **Locate the ID number** of the product on the small white label.
2. Have this number available when you call **800.571.8198** for your customer service representative.

Use only replacement parts supplied by Rifton Equipment.

We are glad to supply replacement parts. Although Rifton makes every effort to supply correct parts and instructions for repairing or refurbishing your equipment, you are responsible to make sure that the repairs or modifications are correctly and safely completed.



Find letters of medical necessity and informative articles at:
www.rifton.com/trike