



Squiggles Stander

User Manual



The Squiggles Stander has been designed to offer the support your child needs in an upright, forward leaning (prone) or rearward leaning (supine) standing posture. The stander is modular in design and interfaces with a choice of bases which have been developed for use in school or at home. This manual shows how to quickly, safely and easily use your Squiggles Stander functions. The instructions on the safety and maintenance will ensure that you will enjoy this product for a long time.

CONTENTS

- 01 Intended use
- 02 Declaration of Conformity
- 03 Warnings and Cautions
- 04 Terms of warranty
- 05 Product history record
- 06 Product training record
- 07 Safety information
- 08 Precautions and Contraindications
- 09 How to unpack and assemble the Stander
- 10 Fitting the cushions
- 11 Clinical setup for postural management
- 12 Frequent adjustments for daily use
- 13 Cleaning & care information
- 14 Daily product inspection
- 15 Annual product inspection
- 16 Reissuing Leckey products
- 17 Product servicing
- 18 Technical information

SECTION 01: INTENDED USE

Intended use

The devices are intended to assist children that cannot stand or maintain a standing position independently as part of a supported weight bearing program.

Indications for use

Squiggles Stander is a standing frame which has been designed for children aged 1-5 for use at home or in the classroom. The standing support frame can be used on the Pivot chassis.

The Pivot chassis has been designed for indoor use on level surfaces. The maximum user weight regardless of which chassis is used is 22kgs (48.4lbs). Suitable for:

- Children with disabilities such as Cerebral Palsy, traumatic brain injuries, muscular dystrophy and other conditions where supported standing programs are encouraged.
- Children presenting with developmental delay who are currently non-ambulating.
- Children where early intervention is indicated.

SECTION 02: DECLARATION OF CONFORMITY

The Squiggles Stander is classified as a Class I Medical Device under EU and UK regulations. James Leckey Design Ltd as manufacturer with sole responsibility declares that the Leckey Squiggles Stander conforms to the requirements of the 93/42/EEC Guidelines, Medical Device Regulations 2017, UK Medical Devices Regulation 2002 and EN 12182 Technical aids for disabled persons and test methods.

Notice to the user and/or patient: Any serious incident that has occurred in relation to the device should be reported to the manufacturer and the competent authority of the Member State in which the user and/or patient is established.



NOTE: General user advice.

Not following these instructions may result in physical injury, damage to the product or damage to the environment!

SECTION 03: WARNINGS AND CAUTIONS

1) WARNING TOPPLING HAZARD

- Never use the product on a sloping surface greater than 5 degrees.
- Always check operation of linear drives, gas struts, and motor drives before use.
- When adjusting the stander angle ensure there is adequate access space on all sides of the product.
- Always lock casters facing outwards before placing the user in the product.

2) WARNING FINGER TRAP HAZARD

- Ensure that the user or carer does not touch any moving joint or pivot that is not locked.
- While the user is in the product, the carer should strive to keep product adjustments to a minimum.

3) WARNING OCCUPANT SECURITY

- User transfers in and out of the product must be done with appropriate equipment and personnel.
- When transferring the user into the product, first use the pelvic band to secure the user.
- Ensure that all harnesses, sandal straps and chest pad are securely applied.
- If the user exhibits any form of distress, remove from the product as quickly as is safely possible.

4) CAUTION FINGER PINCH HAZARD

- While the user is in the product, the carer should strive to keep product

adjustments to a minimum.

- Take care when assembling or adjusting the position of the stander components that your fingers do not get pinched when positioning stander components and tightening mountings.
- During product assembly and adjustment, the carer should avoid finger pinching risk of the product's joints or pivots.
- During transfers and adjustments, the carer should avoid the finger pinching risk of over-centre buckles and latches.

5) CAUTION DAILY CHECKS

- The stander is to be checked daily before use to ensure that all harnesses and stander components are securely attached.
- Always check operation of linear drives, gas struts, and motor drives before use.

6) CAUTION TRIP HAZARD WITH POWERED CHASSIS

- Before moving a powered stander ensure that battery charging connection is removed.

7) CAUTION CLEANING

- Clean the stander regularly to prevent the build-up of dirt. Accumulated dirt can prematurely wear the fabric components and encourage corrosion on the stander. Only use non-abrasive household cleaners and moist cloths,

do not use running water on the upholstery whilst it is still attached to the seat. See section Cleaning & care information.

8) CAUTION CLEANING POWER WASHERS/HOSES

- Hoses and power washers are not to be used to clean the product. Standers with the electric lift system are not sealed against running water and may be damaged by water ingress. See section Cleaning & care information.

9) CAUTION SERVICING/REPAIR OF ELECTRONIC COMPONENTS

- All electronic and electrical components are NOT user-serviceable. Servicing and repairs are only to be carried out by Leckey-authorised personnel.

10) CAUTION DISPOSAL

- When disposing of the product using a community waste disposal site, the frame and any electrical components should be disposed of separately.

11) CAUTION BRINGING INTO USE

- Before use, allow 2 hours for the product to acclimatise to room temperature.

SECTION 04: TERMS OF WARRANTY

The warranty applies only when the product is used according to the specified conditions and for the intended purposes, following all manufacturers' recommendations (also see general terms of sales, delivery and payment). A three year warranty is provided on all Leckey manufactured products and components.

SECTION 05: PRODUCT HISTORY RECORD

Your Leckey product is classified as a Class 1 Medical device and as such should only be prescribed, set up or reissued for use by a technically competent person who has been trained in the use of this product. Leckey recommend that a written record is maintained to provide details of all setups, reissue inspections and annual inspections of this product.

SECTION 06: PRODUCT TRAINING RECORD

(PARENTS, TEACHERS & CARERS)

Your Leckey product is a prescribed Class 1 Medical Device and as such Leckey recommend that parents, teachers and carers using the equipment should be made aware of the following sections of this user manual by a technically competent person:

Section 7

Safety Information

Section 12

Frequent Adjustments for Daily use

Section 13

Cleaning and Care Information

Section 14

Daily Product Inspection

Leckey recommend that a written record is maintained of all those who have trained in the correct use of this product.

SECTION 07: SAFETY INFORMATION

1. Always read instructions fully before use.
2. Users should not be left unattended at any time whilst using Leckey equipment.
3. Only use Leckey approved components with your product. Never modify the product in any way. Failure to follow instructions may put the user or carer at risk and will invalidate the warranty on the product.
4. If in any doubt to the continued safe use of your product or if any parts should fail, please cease using the product and contact our customer care team or local dealer as soon as possible.
5. Carry out all positional adjustments and ensure that they are securely fastened before you put the user into this product. Some adjustments may require the use of a tool which is provided with each product. Keep all tools out of reach of children.
6. When putting the user into the stander both for positional and safety reasons, always secure the pelvic and chest support harnesses first.
7. When the product is stationary ensure that all castors are locked and facing away from the base as this will improve product stability.

This is especially important when the support frame is in a reclined position.

8. When the product is in use please ensure that the angle adjustment lever on the Pivot chassis or the locking bolts on the Easel chassis and Mobile chassis are locked off and cannot be adjusted accidentally, especially if there are children in the area.
9. When the Leckey Squiggles Stander is used on the Pivot chassis we do not recommend that users are moved over uneven surfaces when in the equipment. When using easel chassis always remove the child from the stander before moving. All due care and attention should be taken if transporting the user in and out of the stander.
10. Never leave the product on a sloping surface, greater than 5 degrees. Always remember to lock all the castors.
11. Although the Pivot stander is fitted with castors this is not a mobility device. Always place the user in an upright position before moving the stander. Hold the back of the plastic chest support when moving the stander.
12. The product contains components which could present a choking hazard to small children. Always check that locking knobs and bolts within the child's reach are tightened and secure at all times.
13. Leckey products comply with fire safety regulations in accordance with EN12182. However the product contains plastic components and therefore should be kept away from all direct sources of heat including naked flames, cigarettes, electric and gas heaters.
14. Do not place hot objects greater than 40°C on the tray.
15. Clean the product regularly. Do not use abrasive cleaners. Carry out maintenance checks on a regular basis to ensure your product is in good working condition.
16. The product is designed for indoor use (unless used with the Mobile chassis) and when not in use should be stored in a dry place that is not subjected to extremes of temperature. The safe operating temperature range of the product is +5 to +40 deg Celsius.

SECTION 08: PRECAUTIONS AND CONTRAINDICATIONS

Precautions

- Fixed spinal deformities such as scoliosis or kyphosis
- Severe muscle contractures
- Severe muscular or skeletal asymmetry including hip dislocation
- Progressive and muscle wasting conditions
- High risk or recent history of bone fractures
- High risk of pressure related injury or open sores
- Strong, uncontrolled movement patterns
- Poorly controlled seizure activity
- Children dependent on the use of percutaneous endoscopic gastrostomy
- Medical instability including compromised respiratory or cardiovascular function
- Dependant on 3rd party life-sustaining apparatus such as oxygen tanks
- Significant learning disabilities and/or behavioural issues

Contraindications

- Children experiencing pain or discomfort that cannot be resolved by adjustment of support/positioning
- Children with hip/ knee flexion contracture beyond the limits of the stander

All precautions and contraindications are taken at the discretion of the prescribing clinician or parent. Leckey recommends a trained and experienced clinician to be present during all initial assessment, set ups, configurations, and reissues to minimise risk.

SECTION 09: HOW TO UNPACK AND ASSEMBLE THE STANDER

Check parts

Congratulations on purchasing your Squiggles Stander. When opening the box, cut the straps, taking care not to cut through the tape as you may damage some of the parts contained inside. All of the parts will be contained in polythene bags with each one clearly labelled. Carefully remove them from the box and check you have all the parts you have ordered.

 **Safety First**
Keep polythene bags
away from children.

Multi-tool

A number of adjustments will require the use of the multi-tool, which is supplied with each product.

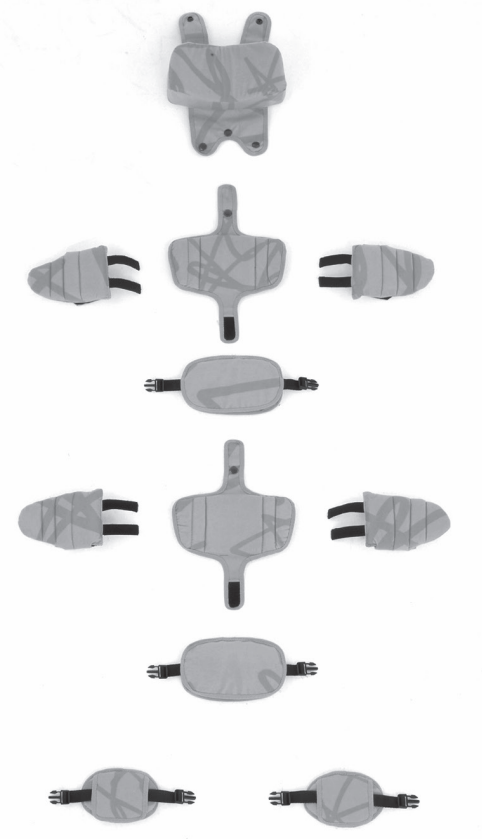

9.1 FOLDING AND UNFOLDING THE PIVOT CHASSIS

The Pivot Chassis can be easily folded for storage or transportation. To unfold, release the levers **A** shown by pressing them together, rotate the rear tubes until the levers engage in the locked position. To fold the chassis simply reverse this procedure.



Always remove the standing support frame before trying to fold the chassis.

Always use caution to ensure fingers do not become trapped when folding and unfolding the pivot chassis.

9.2 ATTACHING THE STANDER TO ITS CHASSIS

The Squiggles Stander can be used as a prone, supine or upright stander and has been designed to fit with three chassis options, the Mobile chassis, Pivot chassis and the Easel chassis.

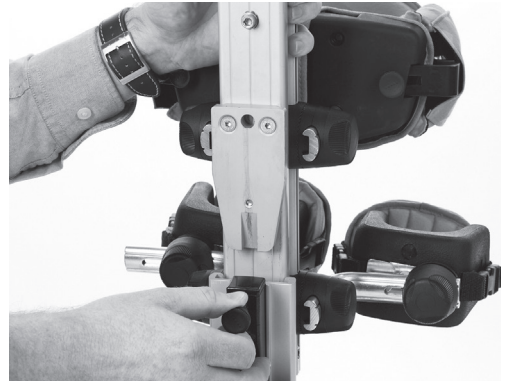

9.3 ATTACHING STANDER TO PIVOT CHASSIS

To attach the stander to the Pivot Chassis, pull the locking pin out, slide the central spine into the receiving bracket until it is fully engaged, release the pin allowing it to snap back into place.



Always make sure the locking pin is fully engaged before you place the child in the stander.





Always make sure the locking pedal is fully engaged before you place the child in the stander.

9.4 ATTACHING STANDER TO EASEL CHASSIS

To attach the stander to the Easel chassis engage the central spine into the receiving bracket until it is fully engaged. Release the locking pin at the side of the pedal by pulling and rotating it through 90 degrees into the locked position. Press the pedal down and locate the locking bar at the base of the central spine in the recess. Release the pedal, the support frame is locked into position. Release the locking pin again so the pedal cannot be accidentally released.



9.5 ATTACHING STANDER TO MOBILE CHASSIS

First insert the support frame into the receiver at the base. To do this release the locking pin at the side of the pedal by pulling and rotating through 90 degrees into the locked position. Press the pedal down and locate the locking bar at the base of the central spine in the recess. Release the pedal, the support frame is now locked into position. Rotate the locking pin again so the pedal cannot be accidentally released. Then slide the central spine interface into the receiving bracket until it is fully engaged, ensuring the locking pin has engaged fully.

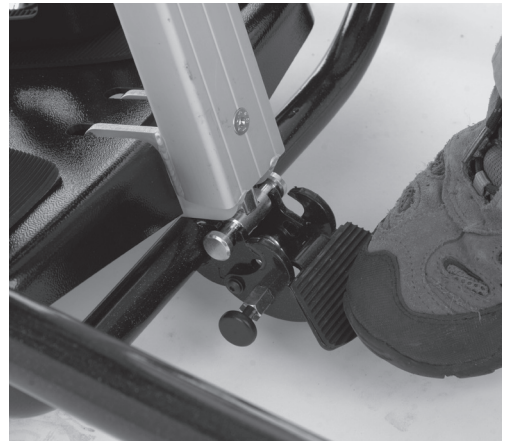



Repeat the process on the opposite side for the other wheel.



Always make sure the locking pin is fully engaged before you place the child in the stander.

9.6 ATTACHING THE SUSPENSION SYSTEM

To attach the suspension system first attach the base which has the suspension spring attached. To do this line up the holes and insert the four bolts and place the washers and nuts onto the bolts. Tighten securely ensuring the bolts protrude through the end of the nut.

Lastly insert the hub assembly into the top and set to the required height for the size of wheels you have ordered. For 27" wheels align the bottom hole **B** in the hub with the top hole in the suspension **C**, insert the bolt and secure with the nut on the other side. To setup the suspension for the 24" wheels align hole **A** with hole **C** and secure with the bolt and nut.

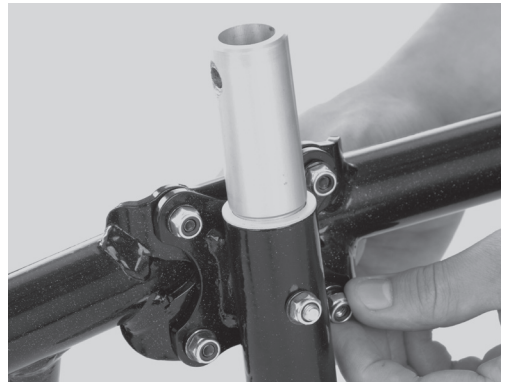

9.7 ATTACHING THE WHEELS

To attach the wheels to the chassis the brakes must be off. Lift the chassis slightly off the ground while pressing the black button in the centre of the wheel. Continue holding the black button, attach the wheel to the chassis then release the black button. To remove the wheels reverse this process.



Always ensure the wheels are engaged securely.

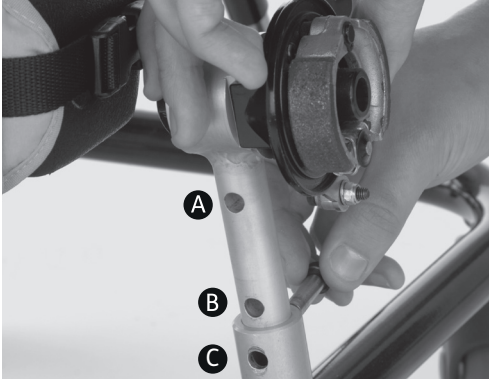

The Whitmyer Lynx head support attaches in the same way. To attach the Whitmyer Pro-Series headsupports remove the spacer collar from the receiving bracket and lock the vertical stem in position using the locking lever.



The product contains components which could present a choking hazard to small children. Always check that locking knobs and bolts within the child's reach are tightened and secure at all times.

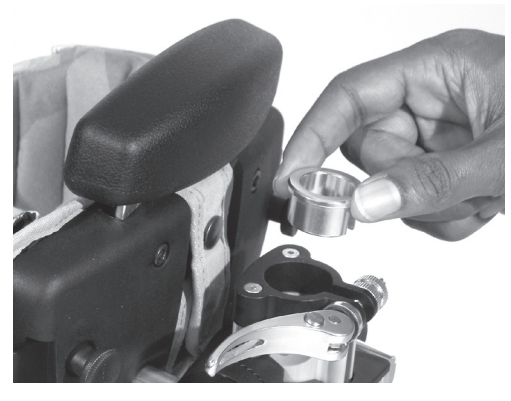

9.8 ATTACHING THE HEADREST

To attach the Leckey head headrest first open the locking lever by pressing the safety button and pulling the handle, then remove the plastic insert from the receiving collar. Then slide the stem into the receiving bracket on the central spine, set to the desired position and secure using the locking handle.



9.9 INSERTING ATTACHMENT BOLT INTO THE SANDALS

Insert the required attachment bolt **A** along with the retention plate **B**. Place a rubber lid **C** on, both, the top and bottom of the sandal. Fasten using the four screws **E** provided. To remove or replace the attachment bolt, reverse this process.

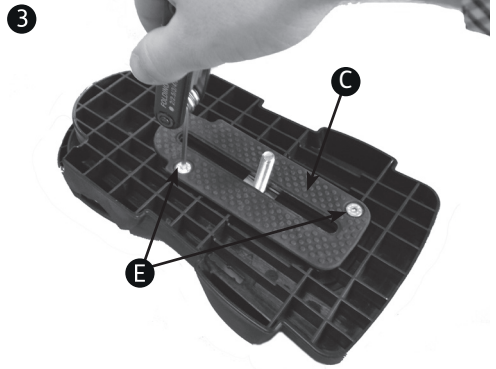

9.10 ATTACHING THE SANDALS

Place the sandal so that the attachment bolt goes through the slot in the footplate. To secure, on the underside of the footplate place the rubber washer **A**, followed by the metal washer **B** and then the knob **C** onto the attachment bolt. To position the sandals simply loosen the knob **C** under the footplate, select the position you require and re-fasten the knob.

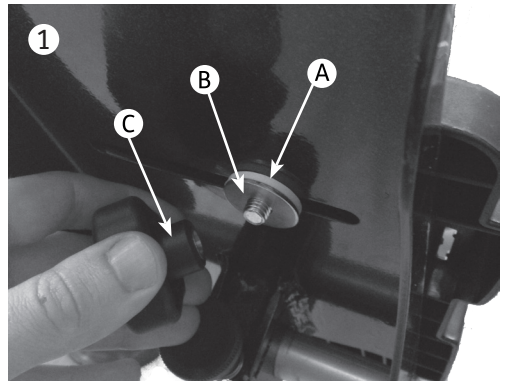
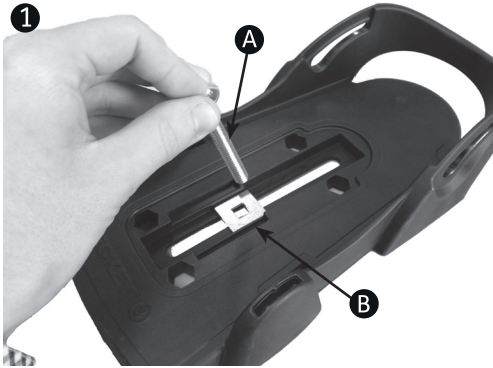

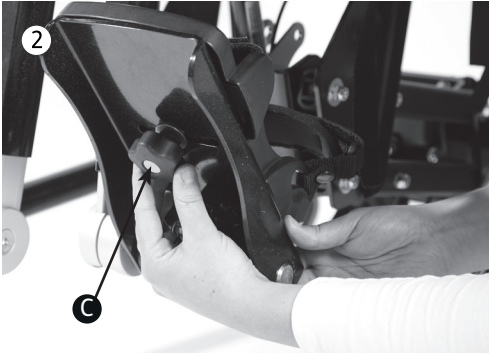

9.11 ASSEMBLE THE TRAY

To attached the arms to the tray brackets, loosen the knob **A**, place the moulding to the inside of the tray plate so the plastic teeth mesh. Replace the knob on the outside and secure. Repeat on other side. Ensure both horizontal tubes are aligned so they locate in the tray bracket receivers.



9.12 ATTACHING THE TRAY COVER

The tray cover attaches to the tray by placing it over the top it will then clip into place, to remove reverse the process.

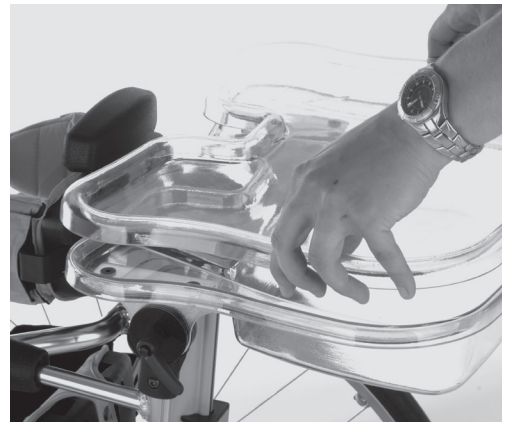

9.13 ATTACHING THE TRAY IN PRONE AND SUPINE

The tray is attached to the stander by inserting the tubes into the receiving brackets. Once the tray is located in position the knobs should be tightened. The cut out of the tray should always be facing the child. To attach the tray whilst in the prone version, ensure that the tray receiving tubes are at their maximum height.

prone



supine



Always use caution to ensure the child's hands or arms do not become trapped when inserting the tray.



9.14 ATTACHING THE GRAB RAIL

To attach the grab rail, inset the receiving brackets **E** in the tray slot and secure with the plastic knob **E**. Repeat on the other side and then sleeve the tubes into the tube **E** and tighten the plastic knob **B**.

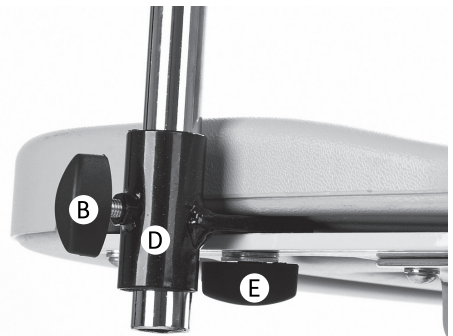

SECTION 10: FITTING THE CUSHIONS

10.1 CHEST AND HIP CUSHIONS

Place the cushion centrally on the chest/hip support plate. Feed the upper tab, which has the snap fastener attached, over the top of the moulding and snap in place. Bring the lower tab under the support and attach the upper tab using the Velcro panels.



10.2 LATERAL CUSHIONS

To attach the lateral support padded cushions, simply slide the cushions on with the padded side towards the inside of the stander. Sleeve the plastic buckle **A** through the slot in the cover. Then bring the two Velcro fastener straps around the bottom of the moulding and attach them to the Velcro panel as shown. Close over the flap **B**.

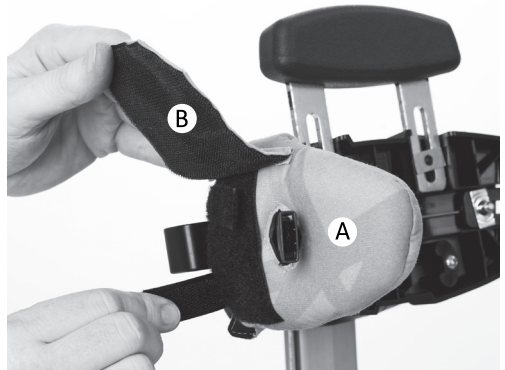

10.3 CHEST SUPPORT HARNESS

The Chest support **A** can be attached by clipping the male buckle into the female buckle at either side of the lateral supports.

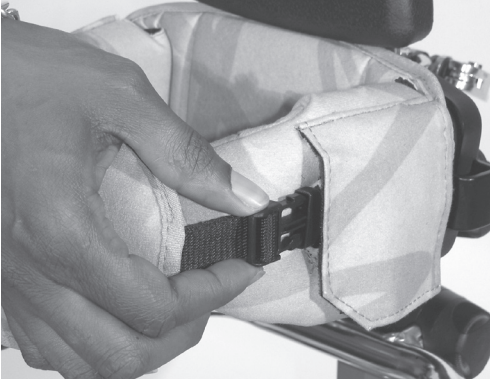

For positional and safety reasons the pelvic harness must be used at all times with the mobile stander.



10.4 PELVIC HARNESS

To attach the pelvic harness, simply slide the left and right sides of the harness over the lateral supports. Sleeve the plastic buckles through the slots in the harness. Then bring the Velcro fastener straps around the bottom of the moulding and attach them to the Velcro panels as shown.

Finally pull the Velcro receiving straps around the user to secure the user in the harness.

10.5 HIP SUPPORT HARNESS

The hip support should be attached around the pelvic harness as an additional safety support should the Velcro on the pelvic harness begin to wear. It can be attached by clipping the male buckle into the female buckle at either end of the pelvic harness.

To adjust the tension lift the front panel, adjust the straps to the required length and then replace the panel.



10.6 KNEE SUPPORT PADS

Attach the knee pads by clipping the male buckle into the female buckle at either side of the knee support, making sure the opening of the front cover is facing downwards as shown.



10.7 PADDED SPINE CAP

Place the padded spine cap over the spine of the standing support and place the plastic loops around the adjustment knobs.



10.8 CONTOURED HEADREST CUSHION

To attach the headrest cushion, place the cushion onto the head support plate, then snap the central fastener and two upper fasteners in place. Bring the lower flap under the plate and snap the two remaining fasteners in place.



10.9 FLAT HEADREST

To attach the headrest cushion, place the cushion onto the head support plate, then snap the central fastener and two upper fasteners in place. Bring the lower flap under the plate and snap the two remaining fasteners in place.

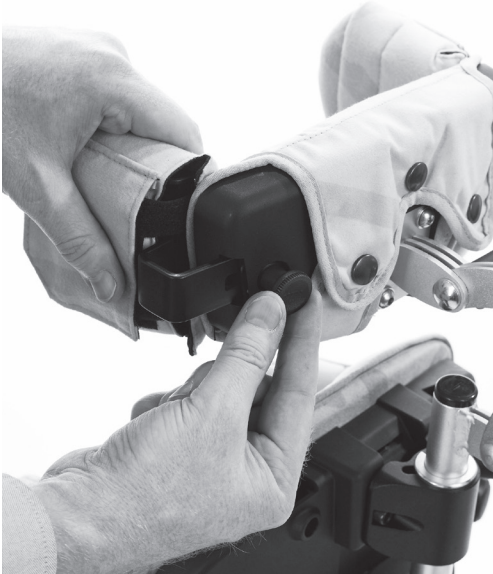

10.10 FLAT HEADREST LATERALS

To attach the headrest lateral covers, simply slide the covers on with the padded side towards the inside of the stander. Then bring the two Velcro fastener straps around the bottom of the moulding and attach them to the Velcro panel as shown. Close over the flap.



SECTION 11: CLINICAL SETUP FOR POSTURAL MANAGEMENT

The clinical setup of the product should be completed by a technically and clinically competent person who has been trained in the use of the product. Leckey recommend a written record is maintained of all clinical setups for this product.

11.1 SETTING THE CHEST SUPPORT HEIGHT

Set the chest support height first by placing the child in a lying position on a mat. Measure the distance from the child's feet to just under their axilla. The height between the top of the chest support and the footplate should be set to this distance.

11.2 ADJUSTING THE OVERALL HEIGHT

The overall height of the standing support can be adjusted by loosening the bolt on the back of the main frame with the multi-tool. Sliding the inner stem to the desired height and retightening the allen bolt. A calibration strip is fitted on the side of the inner frame to help you record the selected positions of the supports. There is also a safety stop at the maximum height.



Never attempt to adjust the height of the main frame when the stander is in use.

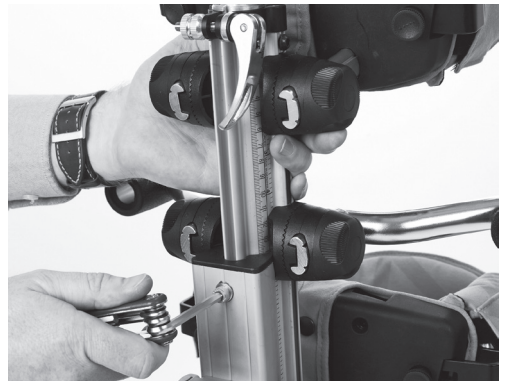

11.3 ADJUSTING THE CHEST AND HIP SUPPORTS

To adjust the chest and hip support rotate knob **A** in a clockwise direction and rotate knob **B** in an anticlockwise direction as shown. Set to the required position and then retighten. The chest support can only be adjusted in angle and depth.



Always use caution to ensure fingers do not become trapped when adjusting the lateral supports.



Always use caution to ensure fingers do not become trapped when adjusting the chest and hip supports.

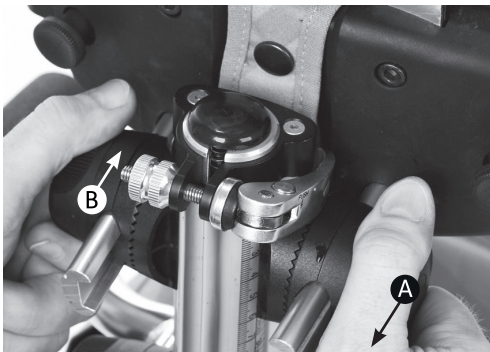

11.5 ADJUSTING THE PELVIC HARNESS

To adjust the pelvic harness pull the Velcro receiving straps around the user until the desired position is achieved.



11.4 LATERAL SUPPORTS

Loosen the hand knob **A** to adjust the width of the lateral supports and retighten when you have achieved the desired position. If the lateral supports are attached with bolts instead of hand knobs they can be adjusted with the multi tool.

11.6 CHEST AND HIP SUPPORT HARNESS

To change the width of the chest harness, lift the front cover, adjust the Velcro straps and set to the desired width and replace the cover.



Always make sure the plastic buckles are fully engaged when using the chest harness.



11.7 ADJUSTING THE STERNUM PAD

The sternum pad can be raised to provide additional support to assist thoracic extension. This also allows the chest support to be set lower to enable greater freedom of arm movement. The sternum plate is adjusted by loosening the two bolts at the front of the chest plate with the multi-tool, set to the desired height and retighten.



Always use caution to ensure fingers do not become trapped when adjusting the sternum pad.



11.8 ADJUSTING THE HEIGHT, DEPTH AND ANGLE OF THE KNEE CUPS

Each knee cup can be positioned independently. To adjust the height, depth and angle of the knee cups, loosen knob **A**, select the height, angle and depth required and retighten the knob securely.

To adjust the width of the knee cup loosen knob **B**, set to the desired width then retighten.

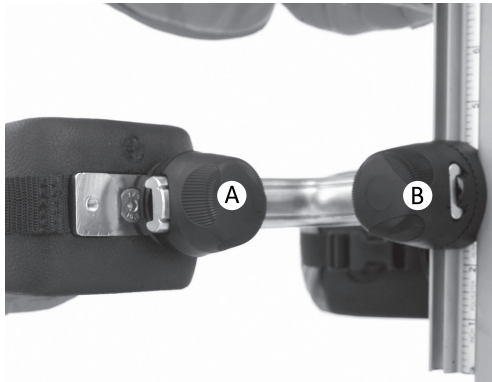

11.9 KNEE PADS

To adjust, lift the front fabric panel, set the belt to the desired length and reposition in place.

Minor adjustments to the knee cups and hip support may be made during use.



11.10 CONTOURED AND FLAT HEADREST ADJUSTMENT

The headrest should only be used when the child is in supine standing. To adjust the height, depth and angle of the contoured headrest, loosen the hand knobs **A** and when set to the desired position retighten the knobs.



Always use caution to ensure fingers do not become trapped when height adjusting the headrest.



11.11 FLAT HEADREST LATERAL ADJUSTMENT

To adjust the width of the laterals loosen plastic knob **A** to desired position and tighten securely.

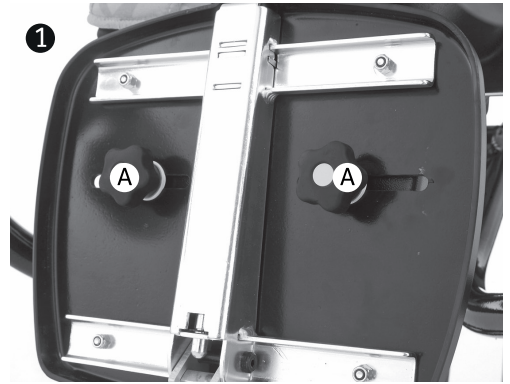
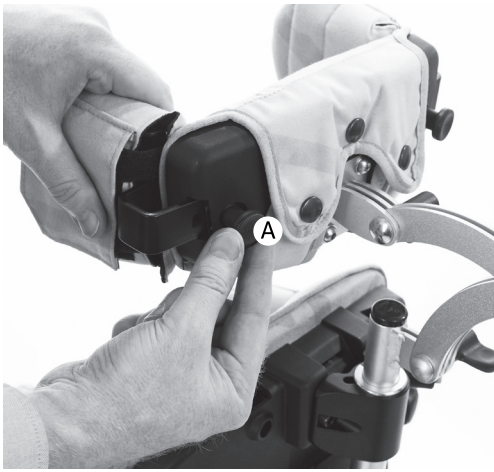

11.12 SANDALS POSITIONING

To position the sandals, simply loosen the knob **A** under the footplate, select the position you require and re-fasten the knob. To position the user's feet in the sandals, secure the Velcro straps provided so the foot is held in place. The straps should be placed over the bridge of the foot and over the toes. The front strap can be fed through one of the two slots on either side of the sandals, depending on the size of the user's feet (3).



If the child is wearing sandals or light footwear check the straps to make sure the webbing does not irritate the skin.

11.13 FOOTPLATE ANGLE ADJUSTMENT

To set the angle to accommodate plantarflexion and dorsiflexion, simply loosen or tighten the allen bolt **B** to set the desired angle.



11.14 PRODUCT CONVERSION – SUPINE TO PRONE

To convert the Squiggles Supine Stander to accommodate prone standing, simply remove the headrest as outlined under “Attaching the Headrest” and attach the tray with the cutout facing the child. Loosen the sandals and turn through 180 degrees and you are ready for prone standing.

prone



11.15 PRODUCT CONVERSION – PRONE TO SUPINE

To convert the Squiggles Prone Stander to accommodate supine standing, simply attach the head support as outlined under “Attaching the Headrest” and attach the tray with the cutout facing the child. Loosen the sandals and turn through 180 degrees and you are ready for supine standing.

supine



11.16 ADJUSTING THE HEIGHT OF THE TRAY IN PRONE AND SUPINE

The height adjustment knobs for the tray are located on either side of the central spine. Rotate knob **A** in a clockwise direction and rotate knob **B** in an anti-clockwise direction as shown, select the required height and retighten.



11.17 ADJUSTING THE DEPTH AND ANGLE OF THE TRAY

Loosen the adjustment knob **C** on either side, slide the tubes along the receiving brackets to achieve the desired depth and retighten the knobs. To adjust the angle of the tray loosen the knobs **E** on either side of the tray, set the tray to the required angle and retighten securely.



Never use the tray to steer or push the chair.

Do not place hot objects on the tray, greater than 40 degrees Celsius.

Please note that the tray is for the use of the user only. Do not lean or place heavy objects on the tray greater than 8kgs (17.6lbs).

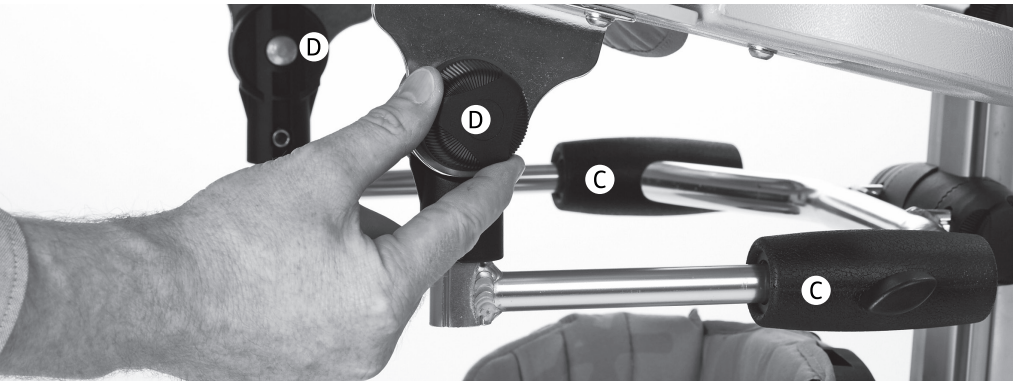

SECTION 12: FREQUENT ADJUSTMENT FOR DAILY USE (THERAPISTS/ CARERS/ PARENTS)

Parents and carers should be shown how to make frequent adjustments and made aware of the safety checks in section 7 by a technically and clinically competent person who has been trained in the use of the product. Leckey recommend that a written record is maintained of all parent and carers who have been trained in the use of this product.

12.1 TRANSFERRING THE USER INTO AND OUT OF THE STANDER

Before transferring the child into the stander carry out the daily product inspection as outlined in section 14 of this user manual.

Before transferring the child into the product lock all the castors, ensuring that they are facing outwards to maximise product stability. Make sure the straps on the chest, hip support harnesses and sandals are released and out of the way to facilitate transfer.

To facilitate transfer into supine standing, angle the support frame to its most horizontal position. This will enable easier positioning of pads and straps while the child is lying on their back.



Always secure the hip and chest support harnesses first.



12.2 CHEST AND HIP SUPPORT HARNESS

To open the chest or hip support harness unclip one buckle and move the harness to one side leaving the other buckle attached. Reverse the process when placing the user back in the product.



Always secure the chest and hip support harnesses first before making other adjustments.

Always make sure the plastic buckles are fully engaged.



12.4 SANDALS

To position the user's feet in the sandals, secure the Velcro straps provided so the foot is held in place. The straps should be placed over the bridge of the foot and over the toes. The front strap can be fed through one of the two slots on either side of the sandals, depending on the size of the user's feet ②.

12.3 KNEE SUPPORT PADS

To remove the kneepads unclip the buckle on the outer side of each kneepad and move to one side leaving the other inner buckle attached. Reverse the process when placing the user back in the product.



Always make sure the plastic buckles are fully engaged.





If the child is wearing sandals or light footwear check the straps to make sure the webbing does not irritate the skin.

12.5 ADJUSTING THE HEIGHT OF THE TRAY IN PRONE AND SUPINE

The height adjustment knobs for the tray are located on either side of the central spine. Rotate knob **A** in a clockwise direction and rotate knob **B** in an anti-clockwise direction, select the required height and retighten.



12.6 ADJUSTING THE DEPTH AND ANGLE OF THE TRAY

Loosen the adjustment knob **C** on either side, slide the tubes along the receiving brackets to achieve the desired depth and retighten the knobs. To adjust the angle of the tray loosen the knobs **E** on either side of the tray, set the tray to the required angle and retighten securely.

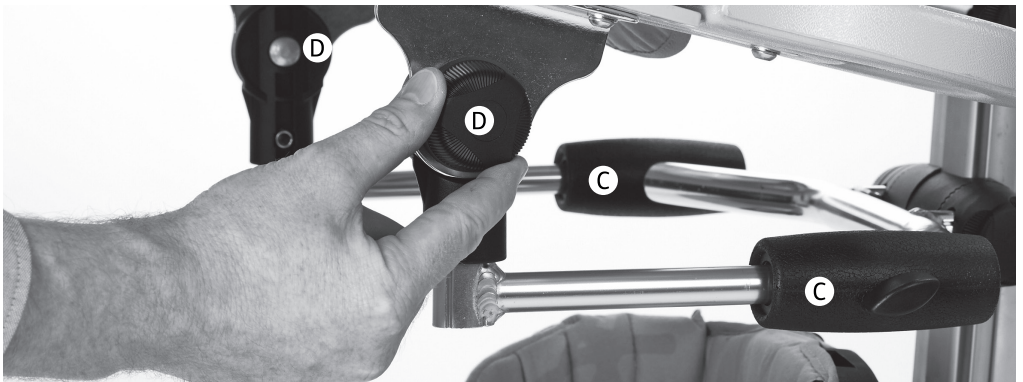



Never use the tray to steer or push the chair.

Do not place hot objects on the tray, greater than 40 degrees Celsius.

Please note that the tray is for the use of the user only. Do not lean or place heavy objects on the tray greater than 8kgs (17.6lbs).

12.7 GRAB RAIL ADJUSTMENT

To set the depth of the grab rail to suit the child's reach loosening knob **E** adjust to the required depth and then re-tighten.

To set the height of the rail, loosen knob **F** slide the rail to the required height and then re-tighten.

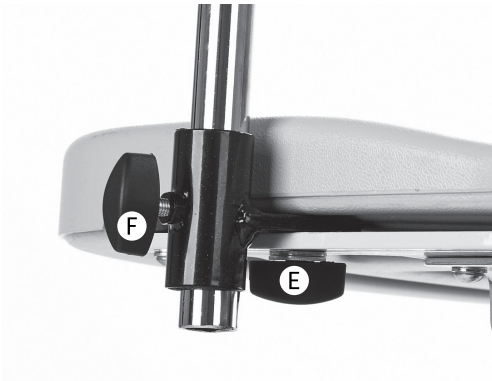

12.8 MOBILE CHASSIS ANGLE ADJUSTMENT

To adjust the angle of the Mobile chassis loosen the two plastic knobs. Press the popper and adjust to the angle required, when the popper has engaged re-tighten the plastic knobs securely.

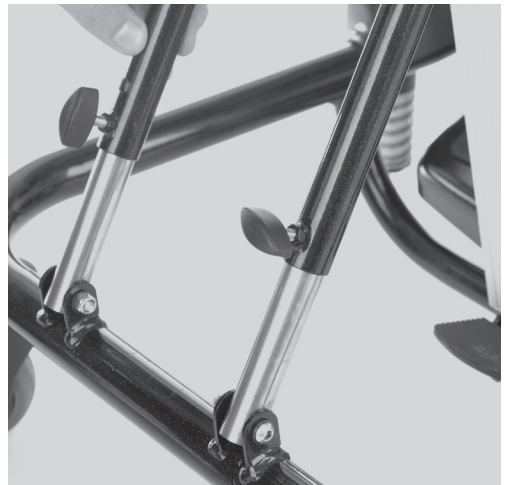

12.9 ADJUSTING THE HEIGHT OF THE SUSPENSION SYSTEM

If you purchase a larger set of wheels for your mobile stander you will need to adjust the height of the suspension system. To adjust the height loosen and remove the nut and bolt at the top of the suspension upright, raise the stem to the higher position, replace the bolt and nut and tighten securely. Repeat the process for the other wheel.



12.11 PIVOT CHASSIS ANGLE ADJUSTMENT

The angle can be adjusted whilst the user is in the stander. You should ensure the child is secured in the stander using the thoracic and hip pads. To adjust the angle of the stander first release the locking pin. To release the pin, pull and rotate plastic knob **A** through 90 degrees into the locked position.

Press the lever **B** down and set the stander to the desired angle. Always re-lock the locking pin **A**.

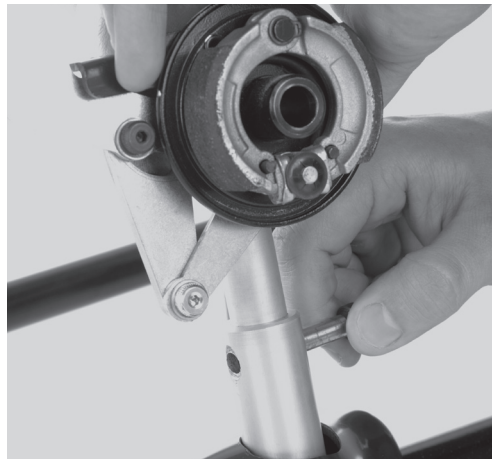

12.10 APPLYING THE BRAKES

To lock the brakes on the mobile chassis push the levers down on either side of the chassis to unlock push the levers up.



Ensure that the product and user are away from surrounding furnishings to prevent possible collision when adjusting the angle of the pivot chassis.

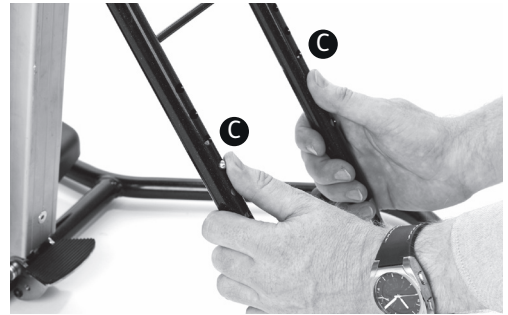
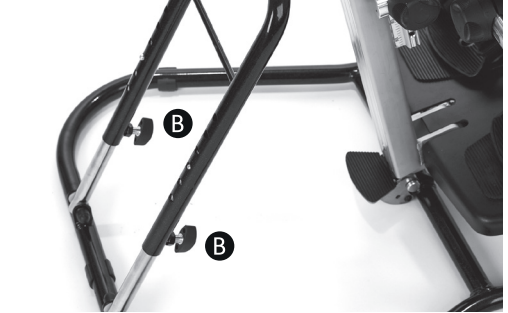
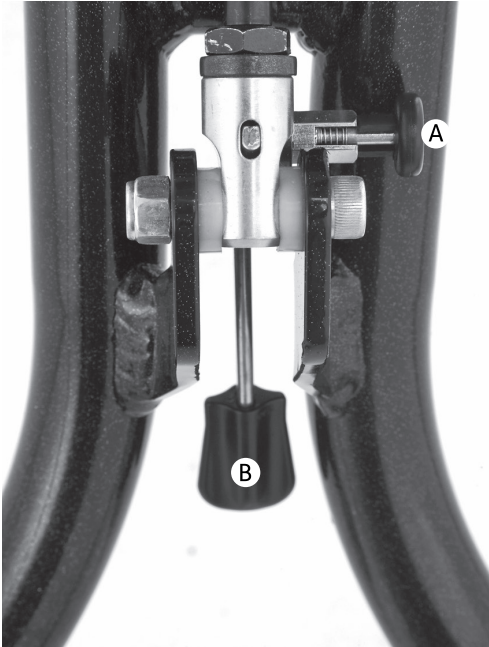

12.12 EASEL CHASSIS ANGLE ADJUSTMENT

To adjust the angle of the Easel Chassis loosen the two plastic knobs **B**. Press the poppers and slide the outer tube to the required angles and engage the poppers **C** again. Finally retighten the plastic knobs **B** securely.

12.13 FOLDING EASEL CHASSIS FOR STORAGE

The easel chassis can fold flat for storage. Remove the main support frame from the chassis. Adjust the outer frame to its minimum position and clip crossbar into the central lock.



Do not adjust the angle of the Easel chassis with the child in the stander.

SECTION 13: CLEANING & CARE INFORMATION

How to Maintain

When cleaning we recommend that you use only warm water and a non-abrasive detergent. Never use organic solvents or dry cleaning fluids.

Upholstery and fabrics

1. The upholstery and fabrics can be cleaned by hand whilst in place. When cleaning we recommend that you use only warm water and a nonabrasive detergent.
2. The best cleaning method is a 'wipe & dry' technique.
3. Staining should be removed as quickly as possible with absorbent cloth, towels or a sponge. Routine soap and warm water sponging is effective for ordinary soiling and minor spills. Be careful not to over wet the fabric as this will cause the staining to spread.
4. Antiseptic cleaning agents can be used on more stubborn stains. These may require a safe solvent such as Isopropyl Alcohol or Mineral Spirit. A half cup of household bleach to 5 litres of water can also be used as a useful disinfectant.
5. Always ensure the product is dry before use.

Metal and plastic components

1. Soap and water or antibacterial spray can be used for daily cleaning.
2. The chassis should be cleaned with a damp cloth- do not use running water.
3. Do not use solvents to clean plastic or metal components.
4. Make sure the product is dry before use.

SECTION 14: DAILY PRODUCT INSPECTION

(Therapists, parents & carers)

We recommend that daily visual checks of the equipment are carried out by therapists, carers or parents to ensure the product is safe for use. The recommend daily checks are detailed below.

1. Ensure all adjustment knobs and bolts are in place and secure.
2. Check all upholstery for signs of wear and tear
3. Check all castors are moving freely and lock securely
4. Check all Velcro strips and brush fluff to ensure straps secure firmly.



If in any doubt to the continued safe use of your Leckey product or if any parts should fail, please cease using the product and contact our customer care team or your local dealer as soon as possible.

SECTION 15: ANNUAL PRODUCT INSPECTION

(Therapist, Technician, LECKEY Product Specialist, Dealer)

Leckey recommend that each product should be subject to a detailed inspection at least once a year and every time the product is reissued for use. This inspection should be carried out by a technically competent person who has been trained in the use of the product and should include the following checks as a minimum requirement.

1. Check all knobs, nuts, bolts and plastic buckles are in place, replacing any missing items. Paying particular attention to the following items;
 - Headsupport locking bolts
 - Chest and hip height and angle adjustments
 - Knee cups adjustment knobs and straps
 - Footrest angle adjustment
2. Check the chassis folding and angle adjustment mechanism is working properly. Also, check that the locking pin on both the Pivot Chassis and Easy chassis engages securely in the pedal.
3. Lift the base to check each castor individually. Make sure they are moving freely and remove any dirt from the rubber wheels. Check that the brakes lock the wheels securely.

SECTION 16: RE-ISSUING LECKEY PRODUCTS

5. Visually check the structure of the product paying attention to weld points on the frame ensuring there are no signs of fatigue or cracking around the welds.
6. Leckey recommend that a written record is maintained of all annual product inspections.

Most Leckey products are assessed and ordered to meet the needs of an individual user. Before reissuing a product we recommend that the therapist prescribing the product has carried out an equipment compatibility check for the new user and has ensured that the product being re-issued contains no modifications or special attachments.

A detailed technical inspection should be carried on the product prior to re-issuing. This should be carried out by a technically competent person who has been trained in the use and inspection of the product. Please refer to **section 15** for the required checks to be carried out.



If in any doubt to the continued safe use of your Leckey product or if any parts should fail, please cease using the product and contact our customer care team or your local dealer as soon as possible.

Before re-issuing a product, we recommend it is disinfected using the following procedure:

Note: Always clean the product first to remove accumulated soiling prior to disinfecting/sanitising

1. Where possible, we recommend the use of an automated “fogger” disinfection system that is used to completely cover the product surfaces with a disinfectant agent. The manufacturer’s instructions for the chosen system should be referred to prior to use and followed exactly.
2. Where an automated disinfection system is not available, all product surfaces should be wiped over with disinfectant surface wipes or liquid disinfectant on a soft cloth. Suitable products are 70% IPA, 70% Alcohol or diluted bleach. The manufacturer’s instructions for the chosen product should be followed. Product upholstery and fabrics should be cleaned thoroughly in accordance with section, Cleaning and Care Information, of this manual.

Ensure a copy of the user manual is supplied with the product. A copy can be downloaded from our website **www.leckey.com**

Leckey recommend that a written record is maintained of all product inspections carried out during the reissue of the product.

SECTION 17: PRODUCT SERVICING

Servicing of all Leckey products should only be carried out by technically competent persons who have been trained in the use of the product.

All international service enquiries should be directed to the appropriate Leckey distributor who will be delighted to assist you. For further information on Leckey distributors please visit our website **www.leckey.com**

SECTION 18: TECHNICAL INFORMATION

Product and Accessory Codes

118-600	Stander support
118-760	Stander covers - green
118-761	Stander covers - orange
118-762	Stander covers - blue
118-763	Stander covers – pink

Chassis

118-764	Pivot chassis
118-765	Easel chassis
129-600	Mobile chassis
129-601	Mobile chassis with suspension

Accessories

Codes prefixed by an asterisk are available in four colour options.

01 - Green	
02 - Orange	
03 - Blue	
04 – Pink	
152-1600	Size 1 Sandals
152-2600	Size 2 Sandals
118-619	Tray
117-769	Grab Rails
118-697	Headrest Support
*137-699	Contoured Headrest

Cushion

*120-792	Flat Headrest Cushion
*120-793	Flat Headrest

Lateral Supports

*120-785	Flat Headrest Complete
129-647 24"	Wheels [Pair]
129-646 27"	Wheels [Pair]
129-631	Suspension Kit
129-629	Transparent Activity Tray

SQUIGGLES STANDER DIMENSIONS

Dimensions	
Ages (approx)	1 - 5
Max User Weight	22.5kg 50lbs
User Height	Min 730mm / 28.5 inches Max 1100mm / 43.3 inches
Chest Support Height [Distance from footplate to armpit]	Min 160mm / 6.25 inches Max 820mm / 9 inches
Chest/Hip Width	Min 160mm / 6.25 inches Max 230mm / 20.8 inches
Hip Support Height [Distance from footplate to mid-buttock]	Min 300mm / 11.8 inches Max 530mm / 20.8 inches
Distance between mid line of knees	Min 140mm / 5.5 inches Max 215mm / 8.4 inches
Footplate	Plantarflexion 10° Dorsiflexion 10°
Mobile Chassis Weights	Without suspension and wheels 6.1kg With suspension without wheels 8.4kg With suspension and wheels 13.4kg
Mobile Chassis Footprint	With Wheels 740mm x 740mm Without Wheels 490mm x 760mm

Dimensions continued**Pivot chassis angle range**90 - 160°
90 - 70°**Tray height - prone**Min 555mm / 21.9 inches
Max 825mm / 32.5 inches**Tray height - supine**Min 480mm / 18.5 inches
Max 825mm / 32.5 inches**Pivot chassis footprint**

(Minimum dimensions for storage)

5.5kg / 12.1lbs
Width 550mm / 21.7 inches
Length 700mm / 27.6 inches
Height 300mm / 11.8 inches**Easel chassis**1.5kg / 3.3lbs
Width 540mm / 21.3 inches
Length 690mm / 27.2 inches
Height 80mm / 2.5 inches**Standard support frame**

(Minimum dimensions for storage)

7kg / 15.4lbs
Width 380mm / 15.4 inches
Length 890mm / 26.8 inches
Height 380mm / 15.4 inches

TABLE OF SYMBOLS



















Symbol	Meaning
	Medical Device
	Read the Instructions for Use
	CE mark
	UKCA mark
	Warning
	Manufacturer
	Serial number
	Product code
	Max occupancy weight
	Date of Manufacture
	For indoor use only
	Latex free

TABLE OF SYMBOLS

Symbol	Meaning
	Unique Device Identification
	Machine wash- water temperature 40°C
	Tumble dry- low heat
	Do not iron
	Do not bleach
	Handwash
	Do not dry clean



USA Distributor

Sunrise Medical [US] LLC
2842 N Business Park Avenue
Fresno, CA 93727

T: 1-800-333-4000
F: 1-800-300-7502
E: customseating@sunmed.com

sunrisemedical.com

Canadian Distributor

Sunrise Medical
237 Romina Drive, Unit 3,
Concord, ON, L4K 4V3

T: +1.800.263.3390
F: +1.800.561.5834
E: mkt.canada@sunmed.com

sunrisemedical.ca

Please visit leckey.com for a full list of Leckey distributors.

**UK
CA**

James Leckey Design Limited
19 Ballinderry Road
Lisburn, BT28 2SA
Northern Ireland

leckey.com

(+44) 28 9260 0750
hello@leckey.com

