HOGGI[®]



BINGO SWITCH User manual

en

User manual for rehab pushchair BINGO SWITCH

| | | |
|----------|--|-------|
| 1 | Model identification | |
| 1.1 | Model identification (label) | 4 |
| 1.2 | Basic configuration | 4 |
| 1.3 | Environmental conditions | 4 |
| 2 | Common information | |
| 2.1 | Preface | 5 |
| 2.2 | Application | 5 |
| 2.3 | Declaration of conformity | 5 |
| 2.4 | Terms of warranty | 5 |
| 2.5 | Service and repairs | 5 |
| 2.6 | Duty to inform serious cases | 5 |
| 2.7 | Product safety / product recalls | 5 |
| 3 | Safety Instructions | |
| 3.1 | Meaning of symbols | 6 |
| 3.2 | Common safety instructions | 6 |
| 4 | Delivery and preparing for use | |
| 4.1 | Delivery and preparing for use | 11-19 |
| 5 | Adjusting and adaptation possibilities | |
| 5.1 | Wheel lock | 20 |
| 5.2 | Height adjustment of the push handle | 21 |
| 5.3 | Seat depth and seat width | 21 |
| 5.4 | Retainer for accessories | 22 |
| 5.5 | Hip supports | 22 |
| 5.6 | Lateral supports | 22 |
| 5.7 | Thigh supports | 23 |
| 5.8 | Back height | 23 |
| 5.9 | Recline | 24 |
| 5.10 | Footrest hanger, angle adjustable | 24 |
| 5.11 | Footrest hanger, 90° | 24 |
| 5.12 | Lower leg length | 25 |
| 5.13 | Footrest angle | 25 |
| 5.14 | Footrest flip up lock | 25 |
| 5.15 | Detaching & attaching the seat unit | 25 |
| 5.16 | Seat unit in opposition to the driving direction | 27 |
| 5.17 | Tilt | 27 |
| 5.18 | Detaching wheels with quick-releas | 28 |
| 5.19 | ASF - Adaptive suspension system | 28 |
| 5.20 | Pneumatic tyres | 28 |
| 6 | Accessories | |
| 6.1 | Swivel lock | 29 |
| 6.2 | Soft accessory bag | 29 |
| 6.3 | Large accessory bag | 30 |
| 6.4 | Headrest pads | 31 |
| 6.5 | Headrest pads (low version) | 32 |
| 6.6 | Headrest bracket „universal“ | 32 |
| 6.7 | Headrest with occiput upholstery | 33 |
| 6.8 | Trunk pads | 34 |
| 6.9 | Lap belt | 35 |
| 6.10 | 4-point lap belt | 36 |
| 6.11 | Five-point harness | 36 |
| 6.12 | Foot straps | 38 |
| 6.13 | Ankle hugger | 38 |
| 6.14 | Groin strap | 38 |
| 6.15 | Fixation jacket | 40 |
| 6.16 | Chest-shoulder harness | 41 |
| 6.17 | Abduction block | 42 |
| 6.18 | Grab rail with upholstery | 43 |
| 6.19 | Therapy tray | 43 |
| 6.20 | Retainer for accessories,grab rail or therapy tray | 44 |
| 6.21 | Winter warmer | 44 |

| | | |
|-----------|--|-----------|
| 6.22 | Sheep skin insert | 45 |
| 6.23 | Rain cape | 45 |
| 6.24 | Canopy incl. adapter and rain cover | 45 |
| 6.25 | Attendant brake | 46 |
| 6.26 | Drum brake | 47 |
| 6.27 | Buggy-Board / Kiddy-board | 48 |
| 6.28 | Sun shade | 48 |
| 6.29 | Accessory and diaper bag | 48 |
| 7 | Transport | |
| 7.1 | In the Trunk of a car | 48 |
| 8 | Maintenance / Service and Repairs and operating life | |
| 8.1 | Maintenance / Service and Repair | 49 |
| 8.2 | Operating life | 49 |
| 9 | Storage | 50 |
| 10 | Recycling and disposal | 50 |
| 11 | Specifications | |
| | All specifications and notes on attachments and accessories | 51-52 |

1.1 Model identification

The mobility base label is mounted on the inside of the left side strut. The seat unit label is attached to the back of the backrest or on the underside of the seat panel next to the knee angle console. When ordering spare parts, please quote the serial number to ensure a trouble-free delivery.

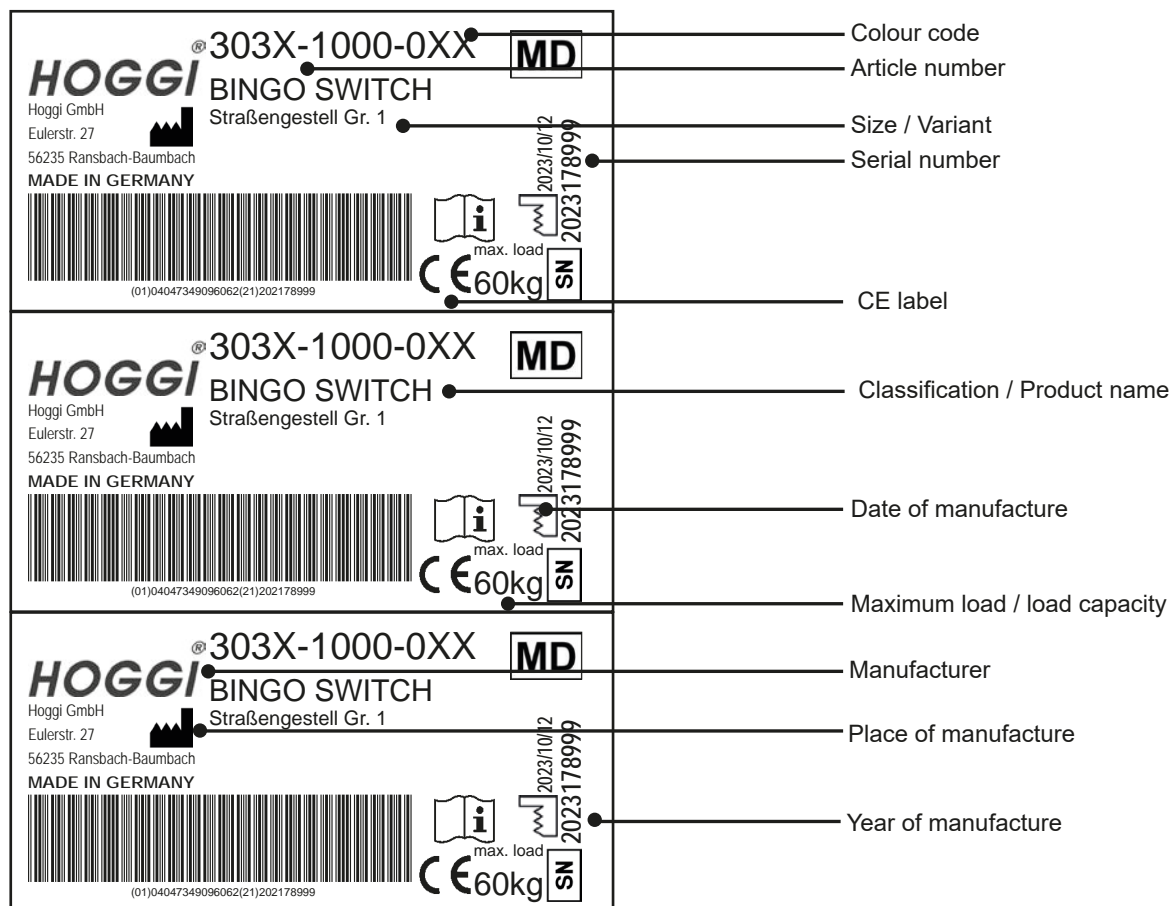

1.2 Basic configuration

- Mobility base and seat unit
- Front and rear wheels with air or PU tires
- Padding (IPS)
- Thigh supports
- Footrest hanger
- Foot rest bracket und footrest

1.3 Environmental conditions

Environmental factors such as temperature and humidity can damage the rehab pushchair. The manufacturer recommends not condensing **BINGO SWITCH** at ambient temperatures between -20 ° C and + 40 ° C and a humidity of 5 to 100%.

Caution: Prolonged exposure to the sun may cause parts of the wheelchair to become hot. Be sure to!

2 Common Information

2.1 Preface

Thank you for selecting the **BINGO SWITCH** rehab pushchair. We have designed this high-quality product to make your life safer and easier, and we've included this manual to help you use and care for it. Please read the following instructions to make sure you use this product as recommended. If you have any further questions, or if you have any problems, please contact your healthcare provider. We hope that **BINGO SWITCH** meets your expectations.

We reserve technical modifications regarding the specified model in this manual. Before using the rehab pushchair the first time, this manual has to be read and understood by patient and support personnel in order to ensure a safe handling with the rehab pushchair.

2.2 Application

Rehab pushchairs, paediatric postural positioning systems or strollers are appropriate for children and adolescents who are unable to walk or who have a walking impediment and thus requiring mobility assistance. Assistance may be required due to: Atypical muscle tone, loss of limbs (dysmelia/lower limb amputation), limb defect and / or deformity, joint contractures, joint defects, general weakness.

The **BINGO SWITCH** rehab pushchair is able to be used indoor and outdoor as well as for further service. For further service the product has to be cleaned and sanitised efficiently. Afterwards the product has to be checked concerning condition, wearout and damage by an authorised technician. All damaged and inappropriate parts need to be changed.

Please see also the service manual for detailed information.

2.3 Declaration of Conformity

HOGGI GmbH as manufacturer declares under sole responsibility that the rehab-pushchair for kids and adolescents **BINGO SWITCH** meets the general safety and performance requirements to Annex I of the Regulation (EU) 2017/745 of the European Parliament and of the Council. Harmonised European Standards have been applied. Applicable harmonized standards have been applied. **BINGO SWITCH** meets the requirements of ISO 7176-8, DIN EN ISO 12182 and DIN EN ISO 12183.

2.4 Terms of Warranty

Warranty applies only when the product is used according to the specified conditions and for the intended purposes, following all manufacturer's recommendations. The manufacturer is not responsible for damages caused by components and spare parts not approved by the manufacturer. See also § 8 of terms and conditions on: www.hoggi.de

2.5 Service and repairs

Service and repairs of **BINGO SWITCH** should only be carried out by authorized **HOGGI** dealers. Should any problems arise, please contact the dealer who supplied your **HOGGI**. Authorized dealers only fit original **HOGGI** spare parts. Spare parts and exchange units are available throughout the life of the product, but only a maximum of 5 years after the last product in the series was sold. **BINGO SWITCH** is made for the first user according to customer requirements. Therefore, no replacement rehab-pushchair is available in the initial configuration. To ensure correct delivery of spare parts, the serial number of your **BINGO SWITCH** is needed. We would be happy to help you find a dealer near you. You can reach us at: info@hoggi.de

2.6 Duty to inform serious cases

All serious incidents that have occurred in connection with the product must be reported to the manufacturer, the specialist trade and the responsible authority.

2.7 Product safety / product recalls

You can find out about new information on product safety and product recalls from specialist retailers or directly from the manufacturer at www.hoggi.de



For preparing, repair and service, the following tools are required:

Allen wrench, size: 3 mm, 4 mm, 5 mm and 6 mm
Screw wrench, size: 10 mm, 13 mm, 19 mm and 24 mm



Further BINGO Evolution documentation:

- Service manual
- Spare parts catalogue

3 Safety instructions

3.1 Meaning of symbols



Caution!
Warning of possible danger of accident and injury.
Warning of possible technical damage.



Information!
About use of product.



Information!
For service-personnel.



Attention!
Read manual before use!

3.2 Common safety instructions



Read manual completely before use!
Familiarize yourself with handling and functions of the product before use and practice the various functions.
You are responsible for the safety of your child. The safety of your child could be affected if you do not follow the instructions of this manual. Nevertheless not all possible circumstances and unpredictable situations can be covered by this manual. Reason, care and circumspection are not features of the product, they are required of persons, who use the product. The person, who is using the product and its accessories should understand all instructions and should explain them to every person using the product and its accessories.
If instructions are not clear and further explanations become necessary, or if you have further questions please contact your **HOGGI** dealer.



Strap your child at all times, when they are in the rehab-pushchair.



HOGGI points out, that any use beside the typical use can be dangerous. The rehab pushchair is not suitable for jogging, running, skating or similar activities. Swivelling front wheels tend to wobble at higher speed, which can cause a sudden stop and tip over of the pushchair.
Use the pushchair only at regular walking speed.
Under no circumstances leave the handle bar while pushing and never push the chair away.



The pushchair should only be used on solid level ground.



Use your pushchair as intended by the manufacturer. For instance, do not drive into obstacles (including steps, curbs) without braking.



To clear obstacles such as steps and curbs, tilt the pushchair onto the rear wheels (pull it backwards to go up; to descend, slowly lower it forward).



Do not go up or down stairs without the assistance of another person. If devices such as ramps or elevators are available, please use them. If they are not available, then the pushchair should be carried over the obstacle by two persons.



Pay particular attention when on slopes and inclines to prevent:

- the child from falling out of the pushchair
- the pushchair from tipping over
- the pushchair from rolling away



Only lift the pushchair by parts that are solidly attached:

- front frame tube above the front wheels
- front axle
- push handle



If you have to park on a slope, face the pushchair uphill with the brakes engaged and ensure that the seat is in the upright position. There is a risk that the pushchair might tip over backwards if the seat is the reclined position.



Before leaving the pushchair and before getting into and out of it, always lock the wheel locks.



When your child reaches for objects in front, to the side or behind the pushchair, be sure that he/she does not lean out of the pushchair too far since the shift in the center of gravity might cause the pushchair to tilt or tip over.



The handling of the pushchair is strongly influenced by tyre pressure. Correctly inflate tyres considerably improve its maneuverability. The air pressure should be at least 2 bar (200 kPa resp. 29 PSI).



Please be aware that with certain footrest settings the footrest can collide with the castor wheels.



Please keep packaging material away from children.
Plastic packaging presents the danger of suffocation.



Never leave your child unattended in the pushchair even when they are strapped in and the brakes engaged.



In the dark, the user should wear light clothing or clothing with reflectors in order to improve visibility. Ensure that the reflectors if installed are easily visible.
We also recommend installing active illumination.



Before using the pushchair, both folding guards and the seat must be firmly locked in place.



Static stability is at 10,5° inclination.
Attaching heavy bags or other weight to the push handles can adversely affect stability.



Caution!
Regard specially during adjusting the recline, the tilt in space function and the footrest hanger angle the danger of getting caught for the child by protruding arms or legs into flexible parts of the **BINGO SWITCH**.



Don't use the footrest to get into and out of the pushchair generally.
Use the footrest with shoes only.



The rehab pushchair is only intended to carry one child at a time.



Disposal of waste: The packaging material as far as metal, aluminium and plastic parts can be recycled. The recycling must be operated according to the national and legal terms.



The maximum weight that can be carried in the accessories bags is 3 kg (model "soft") or rather 8 kg (model "large").
Trays must not be loaded with objects heavier than 5 kg.



Caution!
All upholsteries are hardly inflammable and meet the claim EN 1021 part 1 (cigarette test) and part 2 (match test). But that doesn't protect the user in the seat unit to suffer burnings by careless handling with blaze or open fire.



For storage in the folded situation don't charge the mobility frame (if the tie down kit is mounted).



The maximum load for the **BINGO SWITCH** mobility base is 60 kg.
The maximum load for the **BINGO SWITCH** seat unit is 50 kg.
The maximum load for the **BINGO SWITCH Mini** seat unit is 25 kg.



Accessories and add-ons reduce the maximum load proportionately.



Caution!

Excess strap ends on accessories may be trapped in the tilt mechanism and can avoid the engagement of the locking pins. In such a case the seat could fall off the mobility base.

Shorten excess strap ends on accessories so that they can not be trapped.

Check by pulling the seat sharply forward that the seat unit is properly engaged.

Check that the locking pins are completely engaged. Push in completely, if necessary.



The assembly of a seat shell is only permitted within the specified seating area.
The manufacturer of that new product combination has to test the stability and the adherence of the maximum load before commissioning.



Neither the maximum seat depth nor the maximum back height must be exceeded (see chapter 9).



Please read to visually handicapped people the manual and info material - or use electric aids. Please download or read all **BINGO SWITCH** documents on our homepage www.hoggi.de.

In addition, product videos and product photo galleries are available online!



Whenever you change any settings on the **BINGO SWITCH**, make sure that you firmly tighten any screws that have been loosened



Check the condition of the product if the packaging shows damages.



Be careful in case of extreme temperatures. The wheelchair can heat up significantly when in the sun or in the sauna. In extreme cold, there is a risk of hypothermia. For persons with insensitive skin (ie persons who can not perceive a temperature increase) and / or with skin damage, care must be taken that metal parts do not reach too high a temperature. In these cases, it is imperative to wear appropriate garments to protect the skin.



The **HOGGI** seat cushion (Trevira CS) and the contoured seat cushion (Trevira CS) as well as the **HOGGI** nylon backrest and seat cover are flame resistant referred to the EN 1021-1 and EN 1021-2 norm. When using other cushions and back cushions, as the original supplied by **HOGGI** or used in addition padding, the flame retardant effect is not given.



Always make sure that the quick-release fastener on the rear wheel engages correctly.



4 Delivery and Preparing for Use

Your **BINGO SWITCH** rehab pushchair will normally be supplied completely mounted. Delivery in board: ca. 880 mm (L) x 700 mm (W) x 400 - 450 (H)

Please check the condition of the product if the packaging shows damages. Please remove the transport locks and the transport packaging carefully.



The original package contains the following parts:

- Mobility base, folded
- Solid all-terrain center steering wheel attachment
- Seat unit and backrest, folded
- Seat-, backrest-, hip- and lateral upholstery
- Accessories as ordered
(These have to be mounted on the rehab pushchair by an authorized dealer)
- Instructions and list of tools required



To unfold the **BINGO SWITCH** please proceed as follows:

- Release the unfold safety catch on the left front frame (detail picture).
- Use the black handle grip on the pushbar to lift the pushchair and unfold it until you can set it on its wheels
- Press the pushbar backwards until the folding guards engage hearable.
- Check both folding guards and engage them if it's necessary



- Press down on the quick release with your thumb as shown and place the rear wheel on the rear axle.
- Ensure that the wheels are safely fixed on the axle stub by pulling in the opposite direction.
- Do the same on the opposite side.



- Carefully cut both transport locks (cable ties) on the seat mounts with a pair of scissors or a craft knife (detail picture).
- Pull the backrest and erect it.



- Carefully cut through the transport locks (cable ties) on the attendant brake.



- Turn the toggle lever on the backrest and let engage the backrest in the first position.



- The picture or the mark shows the backrest locked in the first back angle position.



BINGO SWITCH Mini:

- Pull the release strap on the back bar as shown and allow the backrest to engage in the first position (detail picture).



- The illustration or the mark shows the backrest locked in the first back angle position.



- The illustration shows **BINGO SWITCH** with the backrest and the tilt function engaged in the first position.



- After pulling the active handle the angle of the seat unit can be adjusted.



BINGO SWITCH Mini:

- After pressing the thumb lever you can adjust the angle of the seat unit.



If your **BINGO SWITCH** is equipped with an angle adjustable footrest hanger the footrest could be in a hinged position for the transport.

- Swing the footrest hanger with the footrest in the desired position and clamp it firmly with the clamping lever.



If your **BINGO SWITCH** rehab pushchair is equipped with a footrest hanger 90° the footrest could be in a hinged position for the transport.

- Swing the footrest below, pull the locking pin and let it engage hearable.
- Check with a sharp push at the footrest hanger if the locking pin is located securely.



If your **BINGO SWITCH** rehab pushchair is equipped with thigh supports please proceed as follows:

- Position the thigh supports in the desired position on the seat plate.
- Insert the two coach bolts from above as shown.



- Fix both coach bolts with the wing nuts on the underside of the seat panel as shown.



- Secure both screw connections with one Biloc nut as shown.
- Do the same on the opposite side.

If your rehab pushchair is equipped with hip support upholstery, please proceed identically.



BINGO SWITCH Mini:

- Place the hip supports (left) on the brackets (left) as shown.
- Do the same on the opposite side.



BINGO SWITCH Mini:

- The picture shows the left hip support.

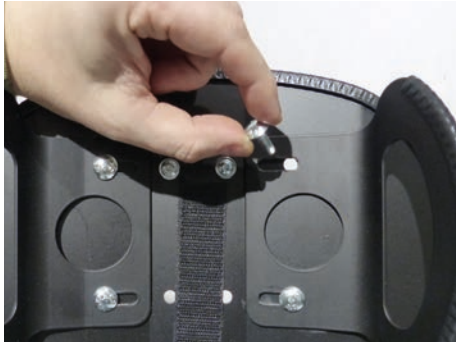

If your **BINGO SWITCH** rehab pushchair is equipped with headrest pads (low version) please proceed as follows:

- Position the headrest pad in the desired position from the front on the backrest plate.
- Insert the two coach bolts from the front as shown.



- Fix both coach bolts with the knurled nuts on the back of the backrest plate as shown.



- Secure both screw connections with one Biloc nut as shown.
- Do the same on the opposite side.

If your **BINGO SWITCH** rehab pushchair is equipped with headrest pads (high version) please proceed identically.



The lateral supports can be detached for the transport to achieve a small pack size.

- Plug the side supports on the backrest tubes as shown.



- The picture shows the **BINGO SWITCH** with the left side support plugged on.



We recommend to adjust the seat unit in the desired position before attaching the upholstery. (Back tilt and seat tilt - see chapter 5).

- Place the seat cushion on the seat panel and fix it to the seat panel with the snaps below the front seat edge as shown.

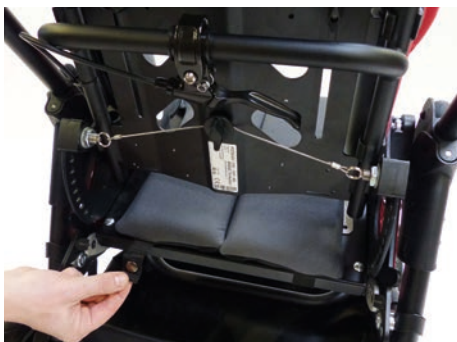

- Also attach the seat cushion with the snaps to the seat panel below the rear seat edge as shown.



- Pull the upholstery of the thigh supports as shown starting from the front, so that the padded side points to the inner side and fix it with the Velcro fasteners.



- The illustration shows the **BINGO SWITCH** with the left inserted thigh supports including upholstery.



- Pull the pad of the hip pad as shown. Starting from the front and fix the Velcro fasteners inside the hip pad and the attached loop tape.



- The illustration shows the **BINGO SWITCH Mini** with a mounted hip support including upholstery.



- Pull the upholstery of the headrest pads (low version) starting from the bottom as shown, so that the padded side points to the inner side and close the zipper.



- The illustration shows the rehab buggy with attached headrest pads including padding.



- Pull the lateral support upholstery onto the bracket, so that the cushioned side points to the inner side and fix it with the Velcro fasteners.



- The illustration shows the **BINGO SWITCH** with inserted lateral support.



BINGO SWITCH Mini:

- For easier attachment, open the zipper of the pad and separate the left from the right.
- Insert the loop from the inside through the front slot and bring it back to the front.
- Proceed in the same way on the other side.

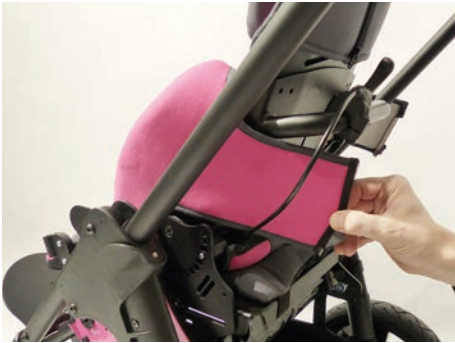

BINGO SWITCH Mini:

- After adjusting, put the pad over the side pads and then connect both halves and close the zipper.



BINGO SWITCH Mini:

- The illustration shows the attached seat cushion.



If your BINGO Evolution is supplied with a canopy we recommend to check chapter 6.24.

- Stand behind or beside the rehab buggy. Pull the backrest upholstery with the cap onto the backrest and fix it on top with the Velcro fasteners.
- Insert the lower end of the backrest upholstery between backrest and seat.
- Guide the Velcro fasteners through the long hole as shown and fix it.



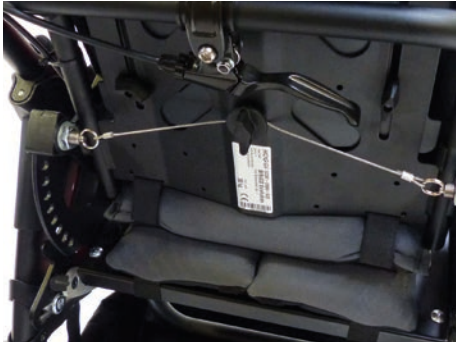

- The illustration shows a fixed backrest upholstery (back view).



To fold the rehab buggy BINGO SWITCH proceed as follows:

- Before folding always ensure the **BINGO SWITCH** with the attendant brake.

We suggest to achieve the most compact folding package:

- to bring the seat angle into the 0° position (see 5.17)
- to fold or to detach the lateral supports (see 5.6)
- to drop off the hip supports (optional (see 5.5)



- to swing up the footrest hanger (see 5.10 or 5.11) and to swing up the footrest (see 5.13).
- Stand behind the pushbar. Pull both folding guards and push the pushbar forwards.
- After activating both folding guards encompass onto the pushbar. Fold the pushbar forwards and keep holding it during the folding process until the **BINGO SWITCH** is folded on the floor.
- Fold the backrest as shown (see 5.9).



- Before folding the **BINGO SWITCH Mini**, we recommend folding the backrest backwards to protect the upholstery.



- The picture shows a **BINGO SWITCH** mobility base with swivelling front wheels.



To switch from the „mobility base with swivelling front wheels“ to the „solid all-terrain center steering wheel attachment“ please proceed as follows:

- Press the release button of the quick-release connection with your thumb as shown and pull the „swivelling front wheel“ at the same time out of the frame.
- Proceed the same way on the other side.



- Insert the „solid all-terrain center steering wheel attachment“ into both frame openings.



- Press the release buttons of the quick-release connections with your thumbs at the same time and allow them to snap into place.



Check that the quick-release connection is securely engaged.



- The picture shows a **BINGO SWITCH** with „solid all-terrain center steering wheel attachment“.



5 Adjusting and adaptation possibilities

5.1 Wheel lock

- To put the wheel lock on push the wheel lock lever downwards and roll the pushchair slightly back or forward, so that the lock pins can engage in the brake disc.



- To disengage the wheel lock pull the wheel lock lever upwards with your toe.



5.2 Height adjustment of the pushbar

The ratchet joints allow adjustment of the push handle to a convenient height. To operate the ratchet joints, push the buttons on the outside of the push handle.

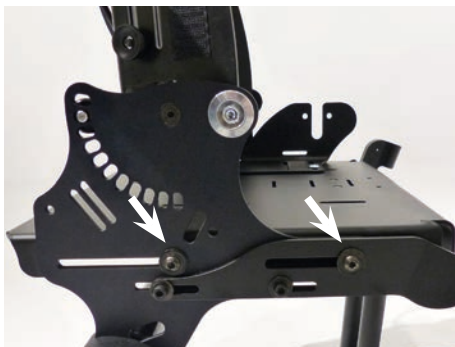

5.3 Seat depth and seat width

After loosening and removing of the marked screw connections (on both sides) it is possible to slide the seat plate. For a high stability the screw connections should have a wide distance to each other.



Whenever you change any settings, make sure that you firmly tighten any screws that have been loosened.

After loosening the wing nuts under the seat it is possible to adjust the seat width continuously variable by sliding the hip supports respectively the thigh supports.

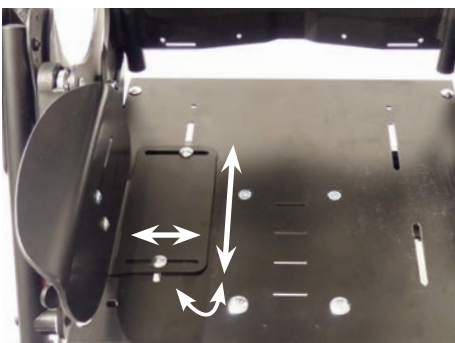

Whenever you change any settings, make sure that you firmly tighten any screws that have been loosened.

The arrows in the illustration show the adjustment possibilities of the hip supports. These are adjustable in width, depth and angle.

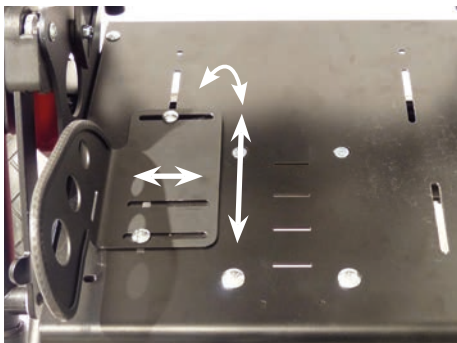

Whenever you change any settings, make sure that you firmly tighten any screws that have been loosened.

The arrows in illustration show the adjustment possibilities of the thigh supports. These are adjustable in width, depth and angle.



The arrows in the illustration show on the left side the adjustment possibilities of the headrest pads (low version) and on the right side the adjustment possibilities of the headrest pads (high version). These are adjustable in width and angle.



Whenever you change any settings, make sure that you firmly tighten any screws that have been loosened.

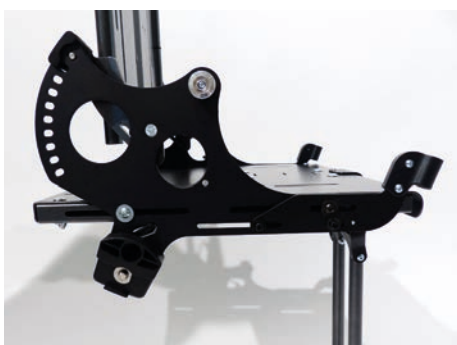

5.4 Retainers for accessories

To fix the grab rail with upholstery or to fix the therapy tray. The retainers for accessories can be mounted in different depths positions to organise the distance between the child and the grab rail respectively the therapy tray variable.

It is possible for the dealer to modify the **BINGO SWITCH** with different depths positions.

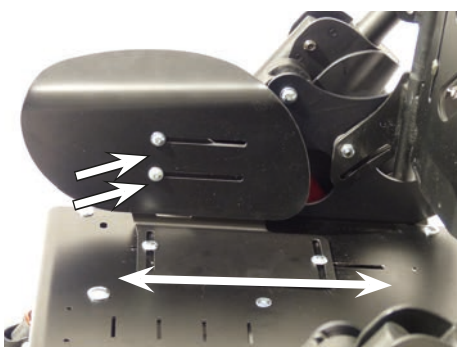

After loosening the wing nuts under the seat the hip supports can be adjusted concerning the depth continuously variable. After loosening the marked screws it is possible to adjust them also on the bracket.



Whenever you change any settings, make sure that you firmly tighten any screws that have been loosened.**5.5 Hip supports**



5.6 Lateral support

- The lateral supports can be detached for the transport.
- A removal of the lateral supports of the **BINGO SWITCH Mini** is not possible.

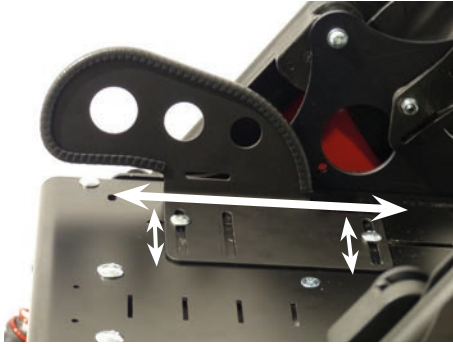

5.7 Thigh supports

After loosening the wing nuts under the seat it is possible to adjust the thigh supports concerning the depth, the width and the angle continuously variable.

See „5.3 Seat depth and seat width“



5.8 Back height

- Loose the wing nuts on the backrest and the cap nuts on the top and adjust your desired back height.
- Firmly tighten the screws that have been loosened.



- From a back height of approximately 55 cm for seat size 1 and 66 cm for seat size 2 the back frame has to be placed on the backrest plate from the top to the bottom position.



Whenever you change any settings, make sure that you firmly tighten any screws that have been loosened.



- To adjust the back strap of the **BINGO SWITCH Mini**, first open the zipper on the back.

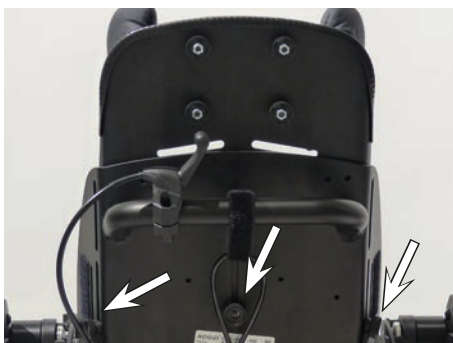

BINGO SWITCH Mini:

- Loosen the three screw connections on the back and then adjust the height of the back insert as desired.
- Close the zipper again afterwards.



5.9 Recline

- Stand behind the seat first and activate the wheel lock of the **BINGO SWITCH**. Secure the backrest with one hand before you operate the toggle lever with the other hand.
- Adjust the backrest into the desired position.



- Stand behind the seat first and activate the wheel lock of the **BINGO SWITCH Mini**. Enclose the handle with one hand and carefully pull the release strap upwards with the same hand.
- Adjust the backrest into the desired position.



5.10 Footrest hanger, angle adjustable

- Activate the wheel lock of the **BINGO SWITCH** and position in front of the seat. Secure footrest and knee angle assembly with one hand before you loosen the toggle lever with the other hand. Swing the footrest to the desired position and tighten the toggle lever firmly again.



- Activate the wheel lock of the **BINGO SWITCH Mini** and position in front of the seat. Secure footrest and knee angle assembly with one hand before you loosen the toggle lever with the other hand. Swing the footrest to the desired position and tighten the toggle lever firmly again.



5.11 Footrest hanger, 90°

If your **BINGO SWITCH** is supplied with a footrest hanger, 90° it is necessary to fold the BINGO Evolution upwards (to achieve the most compact folding size).

- Pull the pin as shown, raise the footrest and swing the footrest hanger to the top.

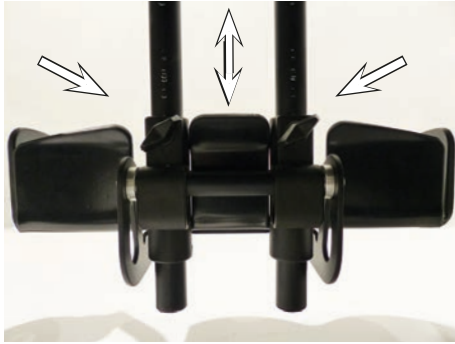

5.12 Lower leg length

- Put the wheel lock on and stand in front of the seat. Secure the footrest with one hand before you loosen the wing nuts with the other hand. Slide the footrest to the desired position and tighten the wing nuts firmly again.



Whenever you change any settings, make sure that you firmly tighten any screws that have been loosened.

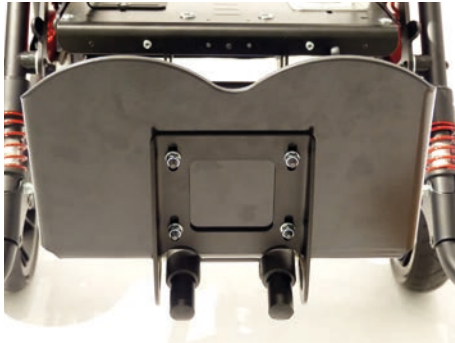

5.13 Footrest angle

The footrest can be raised to get in and out of for transport easily.

- After loosening the 4 bolts under the footrest the footrest can be slid on the hanger.



- This alters the location of the footrest and, therefore, also the footrest angle.
- The angle of the footrest can be adjusted from approximately 80° to 100°.



Whenever you change any settings, make sure that you firmly tighten any screws that have been loosened.



5.14 Foot rest lock (optional)

By pulling the release ring, the foot rest can be folded upwards. When the foot rest is folded down, it will automatically lock into position.



Whenever you change any settings, make sure that you firmly tighten any screws that have been loosened.



5.15 Detaching and attaching the seat unit

To transport BINGO Evolution in a car or to share the weight into two incidents, it is easy to detach the seat unit from the street frame. This is also of value, if you want to use the BINGO seat unit on an (indoor) mobility base.

- Before you detach or attach the seat unit always secure the pushchair by putting on the brake.
- Ensure that the backrest is in the 90° position.



Detaching

- Stand beside the rehab pushchair.
- Tilt the seat unit back to the stop.



- Check whether the red locking button is clearly visible in the slot of the release button (on the side panel).
- Press and hold the release button.



- Pull the active handle of the tilt in space function and swing the seat unit until the locking button adjoins the plate of the seat bracket.
- Catch the seat unit additionally on the footrest hanger and lift the seat unit.



Attaching

- Catch the seat unit on the backrest and on the footrest hanger.
- Position the seat unit, that the seat stands vertically to the floor.

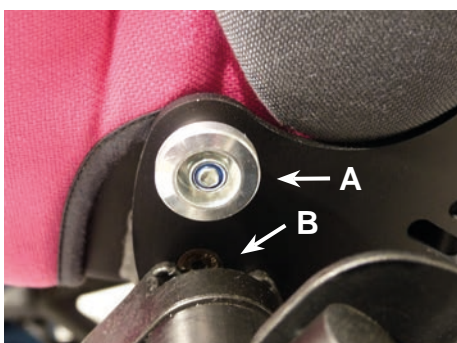

- Attach the seat unit on the street frame and make sure, that the guide shaft (A) slides into the (tilt) bracket (B) on both sides.



- Swing the seat unit until the locking pins engage hearable in the (tilt) base (in the 45° position).
- Adjust the seat unit and the recline into the desired position.



Caution! Excess strap ends on accessories may be trapped in the tilt mechanism and can avoid the engagement of the locking pins. In such a case the seat could fall off the mobility base. Shorten excess strap ends on accessories so that they can not be trapped. Check by pulling the seat sharply forward that the seat unit is properly engaged. Check that the locking pins are completely engaged. Push in completely, if necessary..

5.16 Use of the seat unit in a reverse riding direction

The seat unit can also be used in a reverse riding direction. However, this is not possible with the size 2XL.



5.17 Tilt in space

The **BINGO SWITCH** seat unit can be tilted up to 45°.

- Put on the wheel lock and stand beside the rehab pushchair.
- Secure the seat unit with one hand holding onto the back rest and relieve the locking of the tilt to avoid a stiffness of the release lever.



- This illustration shows the tilt in space of the **BINGO SWITCH Mini**.



- Pull the active handle until the locking bolts enable the tilt in space function and position the seat unit into the desired position.
- Release the active handle and move the seat unit until the locking bolts engage hearable and the tilt in space function locks securely.



Caution! Check with a sharp push at the seat unit if the locking pins are located securely.



5.18 Detaching wheels with quickrelease

The rear wheels of all frame variants and the front wheels of the rigid frame variant can be removed with quick fasteners. Thus, an even smaller folding size be achieved.



- To detach press the quick release spring towards the middle of the wheel and pull the wheel from the axle.



5.19 ASS Adaptive suspension system

The **BINGO SWITCH** can be supplied with an adjustable (4steps), adaptive frame suspension system (ASS).

Different spring sets are available:

- spring set for **BINGO SWITCH Mini** up to 15 kg
- spring set for a load capacity up to 25 kg
- spring set for a load capacity over 25 kg

The scaling on the suspension housing serves as a guide. The number visible from the outside represents the set level.



5.20 Pneumatic tyres

Your rehab pushchair can be equipped with pneumatic tires. The car valves allow checking and adjusting the air pressure at each gas station.

Notice the air pressure indicated on the tyre.

6 Accessories

All accessories not installed by the manufacturer must be installed by trained technicians.

The following notes on installation are for your information but should be performed by trained technicians.



Straps on accessories are usually extra long to accommodate every option. Excess strap ends on accessories may be trapped between the two parts of the seat mounting interface and prevent a full engagement of the lock pin. In such a case the seat could fall off the mobility base. Shorten excess strap ends on accessories so that they can not be trapped. To prevent strap ends from fraying the cut ends can be melted together with a flame. (eg. cigarette lighter).



6.1 Swivel lock

The swivel lock is mounted by the manufacturer or an authorized dealer.

- To lock the swivel lock turn the lock pin by 90° and let it engage in the designated hole in the castor fork.
- To open the swivel lock pull the lock pin, turn it by 90° so that it stays in the disengaged position.



- After loosening the clamping screw the track can be adjusted with engaged swivel lock.



6.2 Soft accessory bag

The **BINGO SWITCH** can be supplied with a soft accessory bag which completely folds with the pushchair, where the carrying capacity is set to a maximum of 3 kg.



The maximum weight that can be carried in the storage bag "model soft" is 3 kg.



- The bag is attached with Velcro fasteners to fix it on the frame.



- Fix the Velcro fasteners on the front frame as shown.
- Proceed in the same way on the other side.



- Fix the Velcro fasteners on the rear frame as shown.
- Proceed in the same way on the other side.



- The soft accessory bag can be used if the seat unit is mounted in driving direction as well if the seat unit is mounted against driving direction.

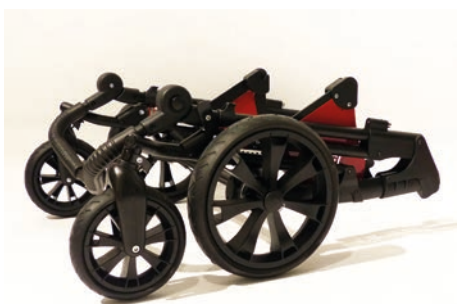

- The illustration shows a folded **BINGO SWITCH** (here without seat unit) including the foldable soft accessory bag.



6.3 Folding accessory bag

The **BINGO SWITCH** can be supplied with an accessory bag which completely folds with the pushchair, where the carrying capacity is set to a maximum of 8 kg.



The maximum weight that can be carried in the accessory bag is 8 kg.



- The „folding, large accessory bag“ offers plenty of storage space.



- The bag is attached to each frame side with a retaining strap for the bag strap and with two straps with rivets and key ring.



- A modification from the „soft“ accessory bag to the „large folding accessory bag“ by the dealer is possible.



6.4 Headrest pads

The headrest pads are mounted with carriage bolts and knurled nuts on the back insert.

- For an easy mounting and for adjustments open the zipper of the upholstery cap on the rear of the back and turn the rear head upholstery back.



- For a rough adjustment of the headrest width the self adhesive foam pads are glued to the left and/or the right of the headrest brackets.



- Put on the cover.
- After loosening the knurled nuts the headrest pads can be moved in or out for a fine width adjustment.

-
- The height adjustment is realized by adjustment of the back insert.



6.5 Headrest pads (low version)

The headrest pads (low version) get mounted identically as the headrest pads. See 6.4. headrest pads.

- For an easy mounting and adjusting open the zip and revert the backrest cushion as shown.



- Put on the cover.
- Close the zip as shown.



- The illustration shows the mounted headrest pads (low version) including upholstery.



6.6 Universal headrest bracket (in connection with backrest until shoulder height only)

The universal headrest bracket gets mounted on the backrest plate. After loosening the adjusting lever it is possible to adjust a inserted headrest in the height.



6.7 Headrest with occiput upholstery (in connection with universal joint)

After loosening the counter nut on the universal joint it is possible to adjust the headrest three dimensional.
 After loosening the upper wing nut it is possible to adjust the headrest by the long hole in the depth.
 After loosening of both wing nuts it is possible to adjust the headrest by using the lock washer. The blank sheet inside the upholstery can be adjusted to the head shape. The cover can be removed for cleaning.



The illustration shows the headrest with occiput upholstery.



6.8 Trunk pads

The trunk pads are mounted to the back with back upholstery removed. The trunk pad gets positioned as shown in the illustration and the screw gets plugged through the long hole in the backrest plate. The triangular pad guiding gets plugged from the back side. The stamping in the pad guiding must be positioned into the long hole. At least a washer get plugged and the wing nut gets firmly tightened. After loosening the wing nut it is possible to adjust the trunk pad steplessly concerning the height. By twisting from the horizontal to the upright position it is possible to adjust the width of the pads to each other.



- After tightening the screws, the back upholstery is pushed underneath the trunk pads.

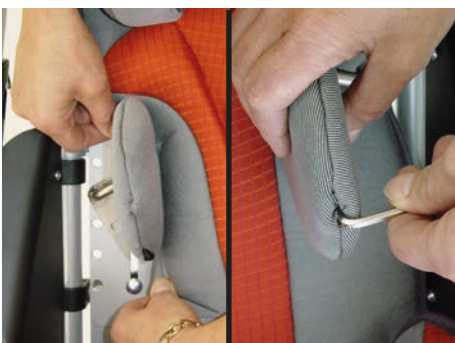

- The angle of the trunk pad is fixed by tightening the clamping screw underneath the trunk pad cover.



Whenever you change any settings, make sure that you firmly tighten any screws that have been loosened.

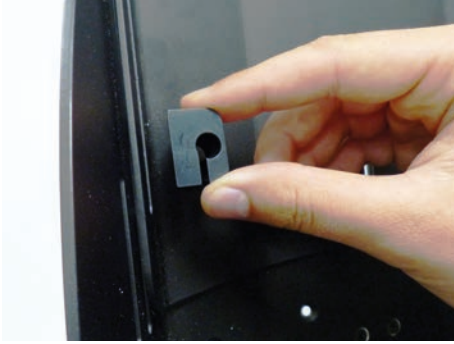

6.8 Trunk pads Mini

- Place the clamp base (right) at the back insert (right side) as shown.
- Please see the next picture for choosing the correct position.



- Insert both screws as shown.



- Tighten the black screw as shown.



- Insert the pad crank with the pads into the clamp base as shown.
- Tighten the silver screw to fix the trunk support.
- Cover the pads with the upholstery.



Proceed on the left side accordingly:

- Make sure that the clamp base is in the correct position.
- Make sure that the screws are in the correct arrangement (silver screw on top and the black screw among).



6.9 Lap belt

Remove the seat- and back upholsteries. Release the lap belts and guide the strap as shown.

The length of the free belt ends determine the length of the complete lap belt.

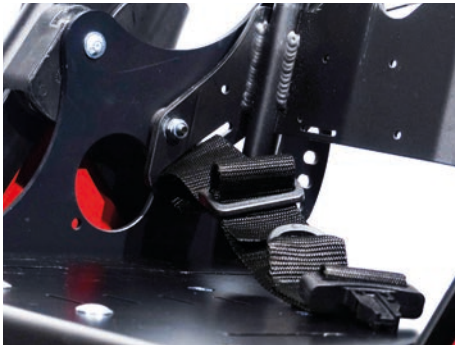

- Then thread the belt ends through the buckle as shown.

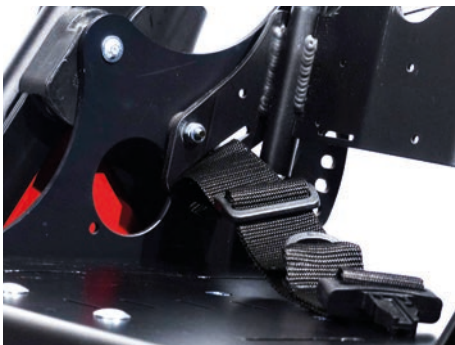

- The illustration shows the fixed belt.

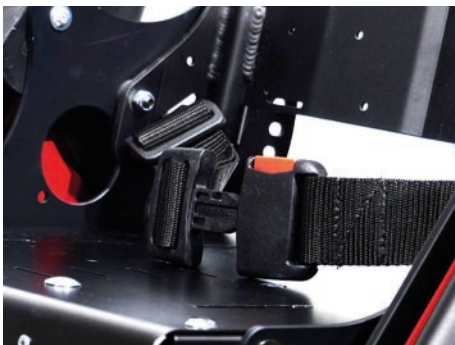

- Proceed in the same way on the other side.
- Then connect both strap ends together and close the strap.



- Open the lap belt by pushing the red key on the buckle.

The lap belt can be adjusted by pulling the belt end next to the buckle (Precision tuning).



6.10 4-point lap belt

The assembly should be performed by trained technicians.

By pressing the plug ends the lap belt opens.

At the belt buckle the lap belt can be readjusted by adducting the lap ends (fine tuning).



- First the seat upholstery have to be removed. Then guide the triglides for the tension belts as shown through the long holes of the thigh supports.



- Then thread the belt ends through the triglides as shown.

The lap ends and the tension belts of the 4-point lap belt get mounted and pre adjusted (length) as described under 6.9 lap belt.

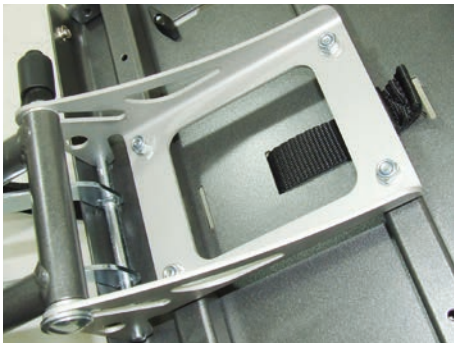

6.11 Five-point harness

The five-point harness should be installed by authorized dealers or trained technicians. Take the seat upholstery off first and turn the seat unit.

In the seat plate are long holes. Choose after adjusting the seat depth one long hole to guide the belt. The position should be close to the body but not underneath the bottom.



- Remove the belt housing and the triglide first.
- Guide the belt end through the seat plate and the seat frame tube until the arrester and guide it to the surface through the chosen long hole.
- Fix the seat cushion and guide the belt upwards through the slot in the cushion.
- To attach the strap to the buckle proceed as described in 6.9 lap belt.



- Remove the buckles from the straps.
- Lead the shoulder straps together with the pad straps through the designated long holes in the back insert.



The shoulder straps are attached in the long holes on the back base. Fix the buckles on the straps as shown in chapter 6.9.

- Tie the pad straps together.



- The shoulder straps should be adjusted in a way that the housing of the length adjusters rest on the shoulder padding.
- Mount the lap strap ends of the five point harness as described in 6.9 lap belt and preadjust them roughly.



To take off the five-point harness proceed as follows:

- Press the red button on the buckle.
- Press the keys of the length adjusters and pull the strap out so that approx 5 cm (2 inches) of the strap end remains.
- Create wide loops which allow for the arms of your child to move out of the harness easily.
- Lift your child out of the seat.



To put the chest-shoulder harness on:

- Place your child into the seat.
- Put the elbow of your child through one of the shoulder strap loops first and then the forearm and hand.
- Proceed with the other arm the same way.
- Put the buckle members one after each other into the buckle.
- Tighten shoulder and lap straps by pulling the strap ends coming out of the length adjuster.



6.12 Foot straps

Thread the foot straps crosswise through the D-rings over the shoe/foot of your child. The heel should be placed against the heel plate of the footrest. Place the buckle always outward. Pull the free strap end to tighten the foot straps. Press the key on the buckle to open the buckle.



6.13 Ankle hugger

Ankle huggers allow a comfortable fixation of the foot joints. They are fixed to anchors on the foot plate. The heel should be placed against the heel plate of the footrest. Velcro straps are used to close the ankle straps and adjust their length. Place the buckle always outward.



6.14 Groin strap

We recommend you to take the seat off the mobility base to mount the groin strap. And remove the seat upholstery.

Position the buckle on the bottom side of the seat panel and insert the screw from the top side of the seat panel into the rear bore hole. Insert the washer and biloc nut. Proceed in the same way on the other side.



- Fix the seat upholstery.



- Guide the straps as shown.



- Insert the buckle and tighten it. Proceed in the same way on the other side.



- The illustration shows the attached fixing clamps of the groin strap.



- Guide the strap from the outside through the long holes of the side plate.



- Guide the end of the strap through the loop and tighten it.



- Thread the plugs onto the straps as shown and cross them.



Caution!
Excess strap ends on accessories may be trapped in the tilt mechanism and can avoid the engagement of the locking pins. In such a case the seat could fall off the mobility base. Shorten excess strap ends on accessories so that they can not be trapped.

To put on the groin strap proceed as follows:



- Place your child into the pushchair on the groin strap.
- The thigh straps are passed between the legs through and over the thighs, at that the part of the thigh belt with the buckle attached should lie on the pelvic bone.
- Insert the male part of the quick-release buckles located on the tensioning straps into the buckles on the thigh belts.
- Tighten the thigh belt by pulling the free end of the strap that comes out of the buckle.
- To disengage the quickrelease buckle, press the key on the buckle.



6.15 Fixation jacket

To attach the fixation jacket straps, rivet (from inside to outside) the six cam-lock buckles to the outside of the back plate. Thread the shoulder straps of the fixation jacket through the shoulder slots to the rear. The centre "axillary straps" must be threaded at the appropriate height between the back frame tube and back plate. Thread the lower straps through the slots in the lower part of the back base (see also 6.9 Lap belt) to the rear.



Thread all straps through the open cam-lock buckles and clamp in position by closing the hinged cam.



Caution!
Excess strap ends on accessories may be trapped in the tilt mechanism and can avoid the engagement of the locking pins. In such a case the seat could fall off the mobility base. Shorten excess strap ends on accessories so that they can not be trapped.



Opening the fixation jacket:

- Open the quick-release buckles on the shoulder part of the fixation jacket.
- Pull the zipper down and open the fixation jacket.
- Lift your child out of the seat.



Closing the fixation jacket:

- Place your child into the seat.
- Close the zipper.
- Tack together the fasteners on the shoulders.



- Readjust the buckles if necessary.

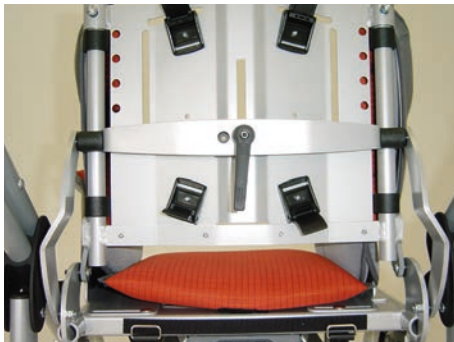

6.16 Chest-shoulder harness

To attach the chest-shoulder harness, rivet (from inside to outside) the four cam-lock buckles to the outside of the back plate. Guide the shoulder straps for the chest-shoulder harness backwards through the designated slots. Thread the lower straps through the slots in the lower part of the back base (see also 6.9 Lap belt) to the rear. Thread all straps through the open cam-lock buckles and clamp in position by closing the hinged cam.



Caution!

Excess strap ends on accessories may be trapped in the tilt mechanism and can avoid the engagement of the locking pins. In such a case the seat could fall off the mobility base. Shorten excess strap ends on accessories so that they can not be trapped.



To put the chest-shoulder harness on:

- Before seating the child in the pushchair, release the four cam-lock buckles on the back plate.
- Pull the chest and shoulder pad slightly to the front, open the hinged cams at the lower end of the pad and pull the straps out.
- Place the straps on the sides of the seat.
- Place your child into the seat.
- Pull the chest and shoulder pad over the head onto the chest.
- Next, thread the straps into the lower cam-lock buckles of the pad all the way to the stop rivets and close the buckles.
- Then tighten the lower straps from behind.



- Make sure that the chest and shoulder pad is positioned symmetrically on the pelvis and close the buckles on the lower straps.
- Set the upper body of your child upright against the back.
- Finally, tighten the upper straps behind the seat and close the buckles on the upper straps

The fit and position of the harness is correct when the straps are not touching the child and when the beaded edge of the harness is not in contact with the strap guide slot.

The harness provides the best upper-body support when the strap guide slot is approx. 2-3 cm above the child's shoulder.



6.17 Abduction block fixed / swing away

The **BINGO SWITCH** can be supplied with a fixed or a swing away abduction block.

You can swing away the swing away abduction block for an easy get in.



To swing away:

- Position in front of the **BINGO SWITCH** and press with one hand the blocking clamp as shown and swing away the abduction block with the other hand downwards.



The illustration shows the swing away abduction block.



To remove:

- Push the button and move the abduction block to the front.



To put on:

- Insert the abduction block and move it up to fix it.



6.18 Grab rail with upholstery

Guide the longer part of the grab rail into one side of the retainer for accessories.

After this guide the shorter end of the grab rail by pressing the snap button into the other retainer for accessories.



To remove the grab rail, stand sideways looking in the direction of the seat unit.

Grasp the top of the retaining bracket from top to left and right. Take off the grab rail by pressing the snap buttons and pull the rail upwards.

The cover is easy to remove by opening the zipper.



6.19 Therapy tray

Insert the tray with the vertical round tubes into the retainer for accessories on the seat unit.

Press the snap buttons and ensure that they point to the side.

To detach the therapy tray see 6.18.



The tray top is adjustable in depth and angle by operating the clamping lever (A). After loosening the screw connections (B) the height adjustable models can be adjusted in the height.

The tray can only be used if the seat is mounted facing forward in driving direction.



Trays must not be loaded with objects heavier than 5 kg (11 lb).



6.20 Retainers for accessories

The retainers for accessories are used to attach the grab rail and the therapy tray.

The retainers for accessories can be mounted in different depth positions to make the distance between child and grab rail or therapy tray variable.

A modification to another depth position by the dealer is possible.



- This illustration shows the retainers for accessories for **BINGO SWITCH Mini**.



6.21 Winter warmer

Zippers allow the upper part of the winter warmer to be opened or removed.

Place the winter warmer in the stroller and tie with the straps.



Upper straps to the frame of the back insert.



Lower straps to the lower area of the back base.



6.22 Sheep skin insert

After removing the upper side of the winter warmer the sheep skin insert gets inserted into the winter warmer.



6.23 Rain cape

With the zip-fastener open pull the rain cape over the child's head, then unfold the upper end over the backrest and the lower end around the footrest.

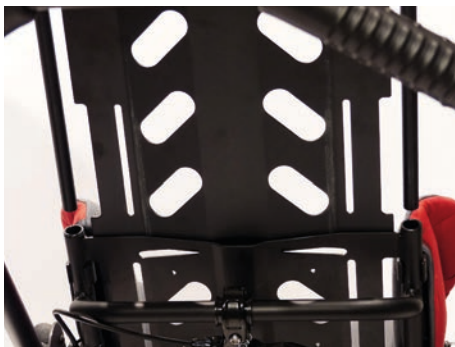

6.24 Canopy incl. adapter and rain cover

First mount the canopy adapters on the back slot. Lose the screws on the back panel and move the back insert out of the back base.



- Insert the adapters as shown.



- Position the adapters into the shown height.



- Tighten the canopy adapters firmly. Proceed in the same way on the other side.



- Insert the male pins of the canopy into the canopy adapters on both sides.



Adjustable ratchet joints are used to set the angle of the canopy.

- Spread the canopy and wrap over the backrest of the seat.



Canopy with rain cover:

Take the rain cover out of the bag attached to the wrap, unfold the rain cover, pull it over the unfolded canopy and put it over the footrest assembly.



The angle adjustment of the backrest is limited because of the transparent rain cover. The angle adjustment is adapted to a seat and knee angle of 90°. Use the space in tilt function to adjust a stationary position. (see 5.17).



6.25 Attendant brake

The **BINGO SWITCH** mobility base can be fitted with an attendant brake. The brake mechanism can be operated with a single lever and a cable switch or with two independent brake lever.



Adjustments:

The attendant brake set is pre-adjusted.

Nevertheless, if adjustments become necessary just after installation or after a period of use there are following options:



At the exit of each brake housing a cranked set screw leads the brake cable away from the tyre of the rear wheel. After loosening the counter nut the pre-tension of the individual (left or right) brake can be adjusted.

Tighten the counter nut firmly again and ensure that the crank of the set screw shows towards the rear frame, away from the tyre.



6.26 Drum brakes

BINGO SWITCH can be equipped with drum brakes too. The drum brakes are activated from the push-bar.



Each drum brake is operated by a brake lever. To apply the drum brake squeeze the brake lever.

With the finger tips press the rocking catch, until it locks with a click and release the brake handle.

When the brake lever is squeezed again, the rocking catch is unlocked and the drum brake can be released.



After loosening the counter nut the initial tension can be adjusted by screwing the guide of the bowden cable.



Whenever you change any settings, make sure that you firmly tighten any screws that have been loosened.



6.27 Buggy-Board / Kiddy-board

To transport a second child **BINGO SWITCH** can be supplied with a detachable buggy or kiddy board.



Buggy- and kiddy board are applicable for children at the age of 2 years and resilient up to 20 kg.



6.28 Sunshade

BINGO SWITCH can be supplied with a sunshade.

For this purpose, the adapter is screwed to the handlebar as shown. The sunshade can be removed from the adapter via a plug-in system. The adapter remains on the frame when folding the rehab buggy.



6.29 Diaper bag

- Black Nylon diaper bag

An extra big changing mat and a thermal bag for a drinking bottle or emergency medication are included. Several storage compartments offer space for diapers, wet wipes and your smartphone.



Attaching heavy bags or similar to the push handle can have a negative influence on the stability.



7 Transport

7.1 In the trunk (luggage space) of a car

Basically you can store your **BINGO SWITCH** in the trunk of your car as well with or without seat unit on as well as with or without wheels on.



To achieve the most compact folding package fold the backrest and remove the rear wheels.

8 Maintenance / Service and Repairs

8.1 Maintenance / Service and Repairs

Your **BINGO SWITCH** is CE approved. The manufacturer herewith guarantees that this medical product as a whole conforms to the basic safety and performance requirements in accordance with Annex I to Regulation (EU) 2017/745 of the EU Parliament and of the Council. The wheelchair should be checked for correct function before every use. Nuts with self-assurance should only be used once. After repeated loosening nuts must be replaced. The items listed in the following table must be checked by the user at the indicated intervals.

| Check | daily | weekly | monthly |
|--|-------|--------|---------|
| Function test of the brake/wheel lock | X | | |
| Check of screw connections | | X | |
| Air pressure (indicated on the side wall of the tyre) | | X | |
| Visual inspection of wearing parts such as wheels and bearings | | | X |
| Contamination on bearings | | | X |
| Quick release (rear wheel) | X | | |
| Check firmness of the footre | | X | |
| Function test of the tilt mechanism | | | X |
| Function test of the adjustment back angle | | | X |

Should any defects become obvious, please contact your authorized **HOGGI** dealer to eliminate them. We also recommend that you have your **BINGO** serviced by your authorized dealer every twelve months.



Instructions for cleaning and maintenance

- Clean all frame components and plastic parts using mild detergents only. (e.g. Sagrotan)
- Padding parts can be washed at 40 °C. If washed in a washing machine, put them in a linen bag or a pillow case.
- In most cases, wiping with a damp cloth is sufficient
- Do not use your **BINGO SWITCH** pushchair in salt water.
- Keep sand or other particles from damaging the wheel bearings
- If your **BINGO SWITCH** gets wet, towel-dry it as soon as possible.
- Hair and dirt particles generally accumulate between the caster wheel and fork. This can restrict the caster wheels from rotating smoothly. Remove the caster and thoroughly clean the fork and caster using a mild detergent
- The rear wheels feature a quick-release system. To keep this system operational, ensure that no dirt adheres to the quick-release axle or axle housing. The quick-release axle should also be lightly lubricated regularly with resin-free sewing machine oil.
- Screw connections should be checked frequently, in particular when beginning to use the wheelchair and after any adjustment. If a screw connection becomes loose repeatedly, consult your dealer.

8.2 Operating life BINGO SWITCH

The expected operating life of the **BINGO SWITCH** rehab pushchair is 5 years, depending on intensity of use and maintenance. We recommend an annual inspection by an authorized **HOGGI** dealer. In case of an interference or a damage of the wheelchair it has to be checked immediately by a dealer or a medical supply store.



9 Storage

BINGO SWITCH can be folded in one piece.



Care instructions!
Clean **BINGO SWITCH** before storage.
Please observe the care instructions on page 51.

10 Recycling and disposal

BINGO SWITCH is made from recyclable materials.

The product packaging as well as all metal, aluminum and plastic parts can be recycled.

Disposal must be carried out in accordance with the respective national, statutory regulations.

Please ask the city / municipal administration for local ones waste disposal company.

11 Technische Daten

| | Mini | Size 1 |
|--|----------------------------|----------------------------|
| Seat width | 130 - 250 mm | 180 - 300 mm |
| Seat depth | 120 - 270 mm | 160 - 340 mm |
| Tilt in space seat unit In driving direction Opposite driving direction | 45° 45° | 45° 45° |
| Backrest height | 370 - 510 mm | 450 - 630 mm |
| Recline backrest In driving direction Opposite driving direction | 80° - 180° 80° - 180° | 90° - 160° 90° - 160° |
| Lower leg length (90° footrest hanger) | - | 160 - 370 mm |
| Lower leg length (footrest hanger, angle adjustable) | 160 - 360 mm | 190 - 400 mm |
| Wheel diameter rear | 290 x 60 mm 300 x 60 mm | 290 x 60 mm 300 x 60 mm |
| Wheel diameter front (rigid / swivel) | 190 x 50 mm 200 x 48 mm | 190 x 50 mm 200 x 48 mm |
| Load capacity * Seat unit Mobility base | 25 kg 60 kg | 50 kg 60 kg |
| Weight** Seat unit Mobility base | 6,4 kg 8,6 kg | 6,4 kg 8,6 kg |
| Overall length Maximum Minimal | 1015 mm 910 mm | 1015 mm 910 mm |
| Overall width Maximum Minimal | 630 mm 600 mm | 630 mm 600 mm |
| Height | 1110 mm | 1110 mm |
| Weight of the heaviest part (seat unit) | 8,6 kg | 8,6 kg |



CAUTION!

*Accessories and add-ons reduce the remaining load capacity for the passenger proportionally.



CAUTION!

The weights refer to a **BINGO SWITCH in basic configuration.

11 Technische Daten

| | Size 2 | Size 2 XL |
|--|----------------------------|----------------------------|
| Seat width | 230 - 350 mm | 230 - 350 mm |
| Seat depth | 220 - 400 mm | 300 - 450 mm |
| Tilt in space seat unit In driving direction Opposite driving direction | 45° 45° | 45° - |
| Backrest height | 540 - 750 mm | 620 - 830 mm |
| Recline backrest In driving direction Opposite driving direction | 90° - 160° 90° - 160° | 90° - 135° 90° - 135° |
| Lower leg length (90° footrest hanger) | 160 - 400 mm | 160 - 400 mm |
| Lower leg length (footrest hanger, angle adjustable) | 190 - 400 mm | 190 - 400 mm |
| Wheel diameter rear | 290 x 60 mm 300 x 60 mm | 290 x 60 mm 300 x 60 mm |
| Wheel diameter front (rigid / swivel) | 190 x 50 mm 200 x 48 mm | 190 x 50 mm 200 x 48 mm |
| Load capacity * Seat unit Mobility base | 50 kg 60 kg | 50 kg 60 kg |
| Weight** Seat unit Mobility base | 7,4 kg 8,7 kg | 7,4 kg 8,7 kg |
| Overall length Maximum Minimal | 1015 mm 910 mm | 1015 mm 910 mm |
| Overall width Maximum Minimal | 680 mm 650 mm | 680 mm 650 mm |
| Height | 1110 mm | 1110 mm |
| Weight of the heaviest part (seat unit) | 8,7 kg | 8,7 kg |

HOGGI GmbH
Eulerstraße 27 • 56235 Ransbach-Baumbach • Deutschland
Telefon: (+49) 2623 / 92 499-0
E-mail: info@hoggi.de • www.hoggi.de